

Technical Information

December 2014



Technical project service

Tel. +49 7223 967-449
Fax +49 7223 967-490
combar@schoeck.com



**Planning tools –
downloads and requests**

Tel. +49 7223 967-449
Fax +49 7223 967-490
combar@schoeck.com
www.schoeck-combar.com

This technical information does not apply to projects in Germany, the Netherlands or Canada. For applications in these countries please refer to the local technical informations Schöck ComBAR®.

The design values and recommendations provided in this technical information represent the best of our knowledge at the time of publication. They are based on international certifications (Germany, The Netherlands) and compliance reports (ISIS Canada, CSA S807, ACI440.3R) as well as on the results of extensive research and testing. They are intended to provide the planner and the designing engineer with a better understanding of Schöck ComBAR®. The information provided in this technical information in no way releases the designing engineer of his duties and responsibilities. It can not replace commonly accepted engineering rules and regulations.



Schöck ComBAR®

Table of contents

	Page
Fibre reinforced composite	4
All types at a glance	5
Product description	6
Product data sheet	7
ComBAR® Bent bars and stirrups	8 - 9
Bar end heads	10 - 11
Dowels	12
Certifications and test reports	13
Storage, transport and machining	14
Applications	15
Tensile strength and modulus of elasticity	16
Durability, characteristic value of the tensile strength	17 - 18
Bond behavior	19 - 20
Crack width	21 - 22
Deflection	23
Thermal behavior	24
Fire resistance	25
Design concept	26 - 29
Table 1: Omega-table for design in ULS	30 - 31
Table 2: Reinforcement for specified w_k (C25/30)	32
Chart 1: Minimum reinforcement for given value of w_{zul}	33
Chart 2: Crack control reinforcement for $M_{Ed} + N_{Ed}$ (C 25/30; $d/h = 0,10$)	34
Table 3: Characteristic values long-term tensile strength ComBAR®	35
Table 4: Required reinforcement for a deflection of $L/250$	36
Table 5.a: Elastic bending of ComBAR® bars	37 - 38
Specifications	39 - 40

Schöck ComBAR®

Fibre reinforced composite

Schöck ComBAR® (composite rebar) belongs to the class of so called fibre composite materials. In fibre composites fibres are combined with other materials to achieve improved properties and synergy effects. The properties of the resulting material can be customized by choosing specific fibres, by adjusting the fibre orientation and by varying the additive and binder contents.

One of the best known composites is glass fibre reinforced polymer (GFRP). It is being used in many fields, such as electronics and ship building, to produce light weight, high strength and extremely durable components.

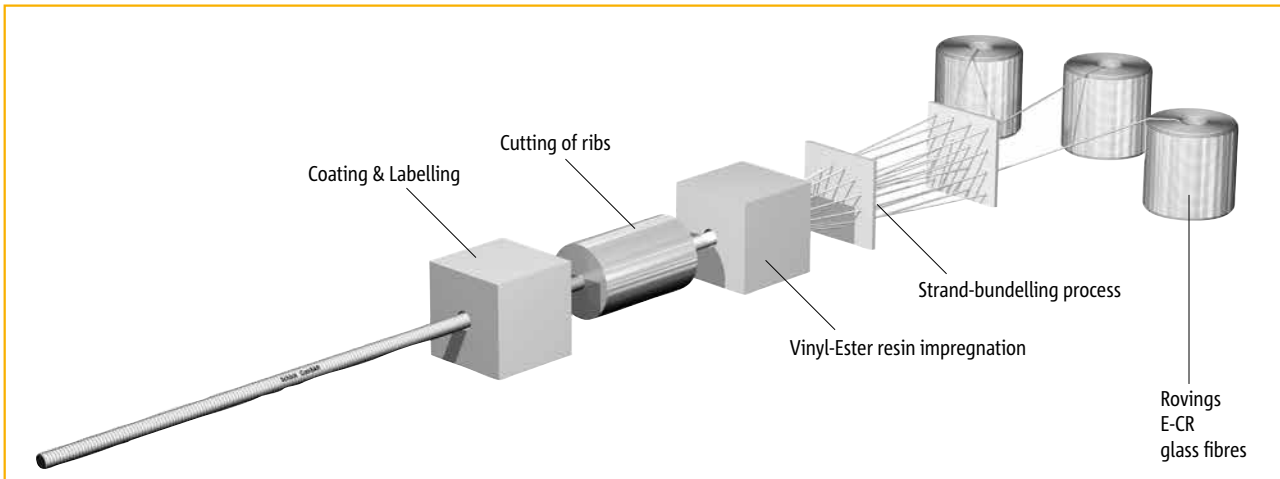

schematic of the "Pultrusion" process

The composite Schöck ComBAR® offers an entirely new range of applications in civil engineering and high rise construction, whenever a high strength, non-metallic, extremely durable, non-corrosive and easily machined reinforcement is called for. The reinforcing bar consists of a multitude of continuous fibres, oriented in the direction of the load, each with a diameter of approx. 20 µm. They are bonded in a resin matrix. The unique production process guarantees the complete impregnation of the glass fibres and an extremely high degree of curing.

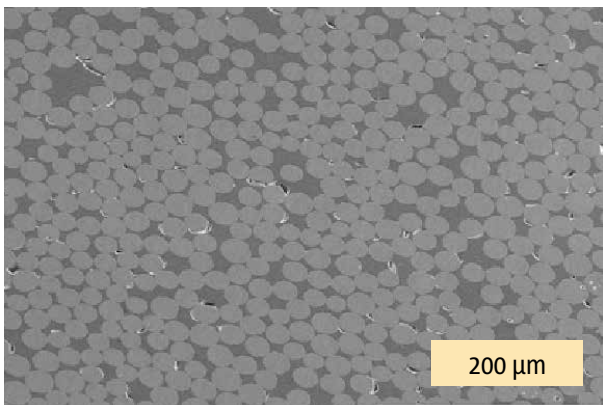

cross-section of a Schöck ComBAR® bar

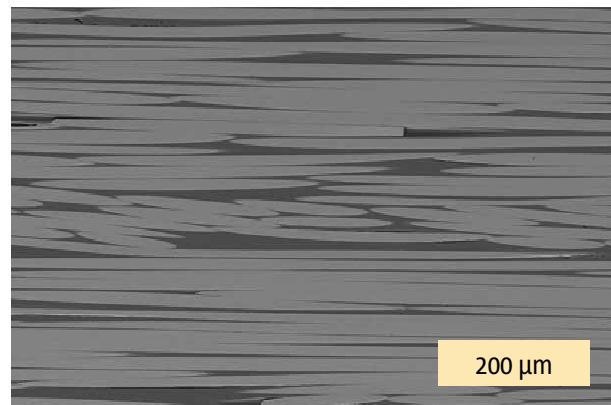

longitudinal section of a Schöck ComBAR® bar



The fibres provide the longitudinal strength and stiffness of the material. The resin matrix holds the fibres in place, distributes the load and protects the fibres against damaging influences.

The unique geometry of the ribs and the fact that the ribs are ground into the hardened bar guarantee bond properties which are analogous to those of steel rebar. High loads can be transferred from the concrete into the ComBAR® bars.

The characteristic material properties of Schöck ComBAR® result from the uni-directional orientation of the fibres: high axial tensile strength, relatively low tensile and compressive strength perpendicular to the fibres. The analogy to the natural construction material timber best describes the non-isotropic material properties. Schöck ComBAR® has been certified in Germany and in the Netherlands. The compliance of 12, 16 and 32 mm straight bars with ACI 440.3R has been certified. The compliance of the 8, 12 and 16 mm straight ComBAR® bars as well as the 12, 16 and 20 mm bent bars with the CSA S807-10 standard has been certified.

Schöck ComBAR®

All types at a glance

	<p>straight bars¹⁾ ∅ 8 mm ∅ 12 mm ∅ 16 mm ∅ 20 mm ∅ 25 mm ∅ 32 mm other diameters on request</p>	<p>standard lengths 0.2 to 11.8 m (sea freight)</p>	<p>▶ As load bearing reinforcement for tensile forces in concrete</p>
	<p>bars with anchorage heads ∅ 12 mm ∅ 16 mm ∅ 20 mm ∅ 25 mm ∅ 32 mm</p>	<p>bar lengths 0.25 to 4.0 m</p>	<p>▶ As end anchorage ▶ As shear reinforcement in slabs and beams</p>
	<p>bent bars/stirrups ∅ 12 mm ∅ 16 mm ∅ 20 mm</p>	<p>bar lengths size up to 1.95m x 1.35m special size up to 2m x 3.2m 0.5 to 6.5 m</p>	<p>▶ As ties / transverse reinforcement for confinement in beams. ▶ As edge reinforcement in slabs, corbels, etc. ▶ As shear reinforcement.</p>

¹⁾ load-bearing core diameters in mm

Delivery Times

Delivery times upon request at +49 7223 967-449.

Accessories

For applications where the reinforcement is to contain no metallic elements at all, Schöck carries plastic spacers (lattice tubes) and plastic clips for the connection of ComBAR® bars at a right angle. Alternatively, ComBAR® bars can be tied using conventional plastic cable ties.

Metal coupler sleeves and wire rope grips are ideal for the connection of ComBAR® and steel reinforcing bars. The sleeves are glued onto the ComBAR® bars in the shop. Specially developed grips with a wire rope shackle can be used for the connection between ComBAR® bars and steel bars with a diameter greater than 32 mm.



clips

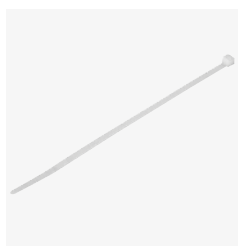

cable ties

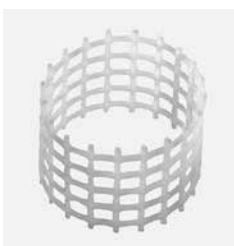

spacers



coupler sleeves



wire rope grips

Schöck ComBAR®

Product description

Schöck ComBAR® was conceptualized as internal reinforcement in concrete members. The mechanical properties and the bond properties are comparable to those of steel rebar. The material properties were tested under predominantly static loads in central European climates. They are certified for a design service life of 100 years.

ComBAR® bars are linearly elastic up to failure. For all bar diameters it occurs at stresses well above 1,000 MPa. As a result of the comparatively low modulus of elasticity of ComBAR®, the failure of ComBAR® reinforced concrete members is preceded by large deflections. When the load is removed the deflection returns to near zero.

ComBAR® bars can not be permanently deformed or bent. A bent bar returns to its original shape as soon as the applied force is removed. Bars with small diameters can be bent elastically (circular tunnel cross-sections). Customised bent bars and stirrups are prefabricated at the shop.

Material characteristics

- high corrosion resistance =>
- high chemical resistance =>
- electrically non-conductive =>
- non-magnetic =>
- ease of machining =>
- very low thermal conductivity =>

Fields of application

- open and underground parking garages, bridge caps, barrier walls, curbs, side walks, approach slabs, wing walls, slim facade elements, shore line stabilisation, hydraulic engineering
- industrial floors, industrial containers, sewage-treatment plants, agricultural facilities
- machinery with high field-strengths, signals and switches of railways
- sensitive electronic equipment, structural biology, nano technology, MRIs
- shaft walls in tunnelling, formwork anchors, building back
- energy conservation in housing construction

properties*	steel rebar B500	stainless steel rebar	Schöck ComBAR®
ultimate tensile strength f_{tk} (N/mm ²)	550	550	> 1000 (see page 16)
characteristic value tensile strength f_{yk} (N/mm ²)	500	500	no yielding
design value tensile strength f_{yd} (N/mm ²)	435	435	445 (see page 17-18)
strain at Ultimate Limit State	2.18 ‰	2.72 ‰	7.4 ‰
tension modulus of elasticity	200,000	160,000	60,000
design value bond strength $f_{bd} \leq C40/50$	acc. EC 2	acc. EC 2	acc. EC 2
design value bond strength $f_{bd} > C40/50$	acc. EC 2	acc. EC 2	3.7
concrete cover (min.)	acc. EC 2	$d_s + 10$ mm	$d_s + 10$ mm
density γ (g/cm ³)	7.85	7.85	2.2
thermal conductivity (W/mK)	60	15	0,7 (axial)/ 0,5 (radial)
coefficient of thermal expansion (1/K)	$0.8 - 1.2 \times 10^{-5}$	$0.8 - 1.6 \times 10^{-5}$	0.6×10^{-5} (axial) 2.2×10^{-5} (radial)
specific resistance ($\mu\Omega\text{cm}$)	$1 - 2 \times 10^{-5}$	7.2×10^{-5}	$> 10^{12}$
magnetism	yes	very little	no

* all values according to EC 2

Schöck ComBAR®

Product data sheet

Bar sizes, dimensions, weights

ComBAR® bar	designated diameter (ACI / CSA)	core diameter (mm)	exterior diameter (mm)	cross-sectional area (mm ²) ¹⁾	weight per meter (kg/m)
ø 8	M8	8	9	50.3	0.13
ø 12	M13	12	13.5	113	0.29
ø 16	M15	16	18	201	0.52
ø 20	M20	20	22	314	0.79
ø 25	M25	25	27	491	1.21
ø 32	M32	32	34	804	1.94

¹⁾ Determination of load-bearing cross-sectional area:

ComBAR® bars are produced in a pultrusion process. The ribs are ground into the hardened bars. Therefore, they do not contribute in any way to the load-bearing capacity or the tensile strength of the bars.

To determine the load-bearing core cross-sectional area of the perfectly round ComBAR® bars the exterior diameter is measured using callipers. Twice the depth of the ribs, measured with callipers, is subtracted from this value to determine the core diameter.

Methods for the determination of the average cross-sectional area of FRP bars according to CSA S806, ISIS Canada and ACI440 have been developed for sand-coated bars or bars with a deformed surface. They are not applicable to ComBAR® bars.

Material properties straight bars

properties	symbol ¹⁾	values	remarks
characteristic value short-term tensile strength	f_{fk0}	> 1000 N/mm ²	
char. value long-term tensile strength	f_{fk}	580 N/mm ²	see page 17 - 18
material safety factor	γ_f	1.3	
design value long-term tensile strength ²⁾	f_{fd}	445 N/mm ²	
tension modulus of elasticity	E_f	60,000 N/mm ²	see page 16
strain at Ultimate Limit State ²⁾	$\epsilon_{f, ULS}$	7.4 ‰	(at $f = 445$ N/mm ²)
design value bond strength	f_{bd}	2.3 (N/mm ²) 3.0 (N/mm ²) 3.7 (N/mm ²)	C20/25 C30/37 C40/50 and higher
transverse shear strength ³⁾	τ	150 N/mm ²	not for design of dowels!
concrete cover	c_v	$d_s + 10$ mm	all exposition classes precast: $d_s + 5$ mm
density	γ	2.2 (g/cm ³)	
thermal conductivity	λ	< 0.7 W/mK	
coefficient of thermal expansion	α	0.6 x 10 ⁻⁵ 1/K (axial) 2.2 x 10 ⁻⁵ 1/K (radial)	concrete: 0.5 - 1.5 x 10 ⁻⁵ 1/K
critical temperature	–	400°C	see page 24 and 25
specific resistance	–	> 10 ¹² μΩcm	
chemical resistance	–	excellent	
electro-magnetic conductivity	–	none	
environmental properties	–	Z0	acc. to LAGA (Germany)
char. one thousand hour strength (40 °C) ⁴⁾	$f_{fk 1000 h}$	950 N/mm ²	all bar diameters
logarithmic temporal slope ⁴⁾	R10	< 15%	at 40°C; per log. decade

¹⁾ all symbols according to EC-2 / fib

²⁾ at 40°C (permanent); for statically determinate structures, for indeterminate structures : $f_{fd} = 370$ N/mm², $\epsilon_{f, ULS} = 0.61$ %

³⁾ values in tests according to ACI / CSA - not for design of shear dowels!

⁴⁾ for determination of long-term tensile strength acc. to fib bulletin 40 (see pages 17 - 18)

Schöck ComBAR®

ComBAR® Bent bars and stirrups

ComBAR® bent bars and stirrups are produced by bending a specially made polypropylene conduit pipe filled with glass fibres and a vinyl ester epoxy resin into the desired shape. These raw bars are then thermally cured. This procedure allows for a high fibre content and a nearly parallel alignment of the fibres in the bent portion of the bars, resulting in high strength and a modulus of elasticity similar to that of straight ComBAR® bars.

ComBAR® bent bars can be produced in all bending shapes (2D) known for bent steel rebar. Spirals, 3D bars and bending in two directions are also possible. The smallest pin diameter is seven times the nominal bar diameter. Bent ComBAR® bars are cured in a form with maximum dimensions 1.95 x 1.35, special sized stirrups up to 1.95 by 3.15 m.

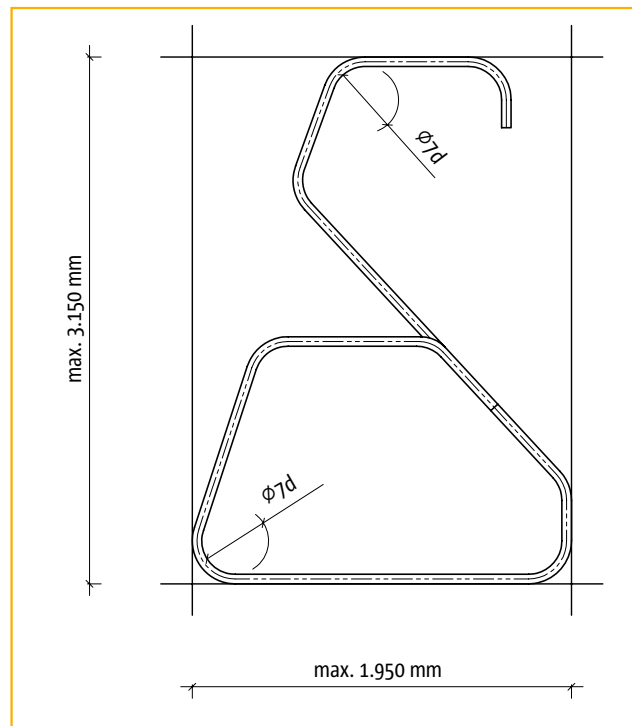
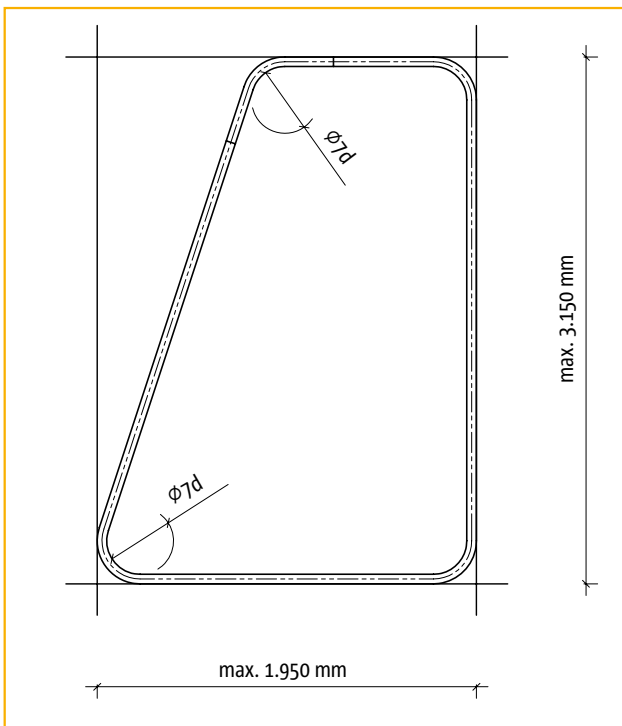

Bar sizes, dimensions, weights of bent bars

nominal diameter (mm)	core diameter (mm)	exterior diameter (mm)	core cross sectional area (mm ²)	specific weight (kg/m)	min. pin diameter 7 d _b (mm)	min. / max. bar lengths (m)
12	11.6	15.5	106	0.30	84	0.5 m / 6.5 m
16	15.6	19.8	191	0.48	112	
20	19.1	23.8	287	0.69	140	

Schöck ComBAR®

ComBAR® Bent bars and stirrups

Fibre content, cure ratio

The fibre content of ComBAR® bent bars (all diameters) is approx. 65% (by weight, including the ribs).

Tensile strength, modulus of elasticity, durability

The modulus of elasticity of ComBAR® bent bars is 50 GPa. The partial factor of safety is 1.3 (German certification ComBAR®).

The long term tensile strength of ComBAR® bent bars was determined according to the durability concept specified in the German certification of straight ComBAR® bars. The specified tensile strengths are determined for a design service life of 100 years at 40°C effective temperature in highly alkaline concrete. (Please refer to pages 17 - 18)

nominal diameter (mm)	ultimate tensile strength* f_{tu}		characteristic value f_{fk}	design value f_{fd}	modulus of elasticity E_f^{**}
∅ 12	1000 N/mm ²	600 N/mm ²	250 N/mm ²	192 N/mm ²	50.000 N/mm ²
∅ 16	950 N/mm ²	600 N/mm ²			
∅ 20	600 N/mm ²	600 N/mm ²			

* larger value in straight section, smaller value in bend

** mean value of m. o. e.

Bond properties

Maximum values of the bond strength f_{fbu} in the straight portion of the bars and in the bends (end anchorage of bar) are (embedment length 5 and 10 times bar diameter C20/25):

nominal diameter	straight section	bend
∅ 12, 16	8 N/mm ²	10 N/mm ²
∅ 20	10 N/mm ²	12 N/mm ²

For all bar diameters (bent bars) and independently of the concrete strength the design value of the bond strength should be set to

$$f_{fbd} = 2.3 \text{ N/mm}^2$$

In poor bond conditions this value is to be reduced to 1.6 N/mm² in accordance with EC 2.

Critical temperature

The critical temperature of ComBAR® bent bars is approximately 120°C.

Schöck ComBAR®

Bar end heads

ComBAR® bar end heads are used to reduce the embedment length of straight bars in geometrically constrained reinforcement situations or as shear reinforcement in diaphragm walls and drilled piles (double headed bolts).

ComBAR® bar end heads are made of polymeric concrete. They are cast onto the ends of straight ComBAR® bars. The special geometry of the end heads insures minimal tensile splitting forces at the head. As a result, ComBAR® end heads can be installed very close to the concrete surface and still develop the full design force.

The long-term behaviour / durability is governed by the behaviour of the bar. Long-term pull-out tests have been performed on bars with end heads cast into highly alkaline concrete cubes. The bars were subjected to constant loads until failure occurred. The concrete cubes were heated to 60°C and saturated with water over the duration of the tests. The time-to-failure line for the headed bars was established using the results of a large number of tests at different load levels. The characteristic value of the anchorage strength of the headed ends was determined for applications with a maximum effective temperature of 40°C (for projects in North America and central Europe). This procedure corresponds largely to the durability concept specified in the German certification of straight ComBAR® bars. Refer to pages 17 and 18 for further details on the durability concept.

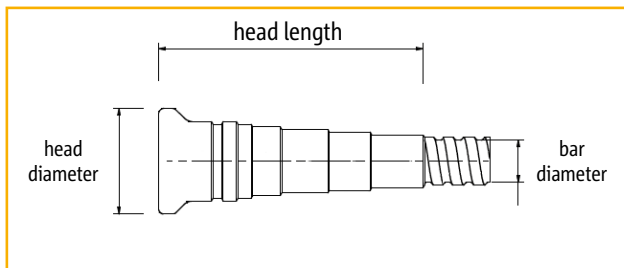

Dimensions, anchorage force end heads

bar diameter (mm)	head length (mm)	head diameter (mm)	min. bar length (d _{hb}) in mm	max. bar length	F _{head,k} short term (kN)	F _{head,k} long term (kN)
12	60	30	160	4.0 m	50	31
16	100	40	240		100	68
20	100	45	240		125	85
25	100	50	240		156	106
32	100	64	240		200	136

Schöck ComBAR®

Bar end heads

The required embedment length of straight ComBAR® bars can be reduced by installing bar end heads. The long term load (design value) which can be anchored by the end heads was determined in durability tests. This value is to be subtracted from the total load which is to be anchored to determine the portion of the load which has to be anchored by the adjoining bar. Accordingly, $l_{b,net}$ is determined by adding the length of the head $l_{b,head}$ and the anchorage length of the bar $l_{b,net,bar}$.

$$F_d = F_{head,d} + F_{bar,d}$$

$$l_{b,net} = l_{b,head} + l_{b,net,bar}$$

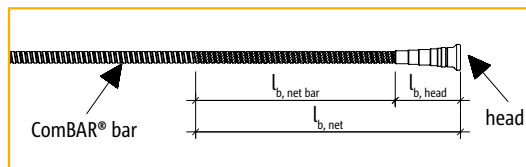

The end heads of ComBAR® double headed bolts used as shear or punching shear reinforcement need to be fully anchored by the longitudinal / transverse reinforcement.

The load is transferred over the entire length of the head. At least one transverse reinforcing bar is to be installed perpendicular to the head near its end. This insures that the head is fully anchored. In the design of shear reinforcement only the force anchored by the longitudinal reinforcement or an additional transverse bar (see figure below) may be considered.

ComBAR® bars with end heads may be placed directly onto the form work (concrete cover $A \leq 0$ mm). The concrete cover parallel to ComBAR® bars with end heads should not be less than 50 mm (concrete cover B).

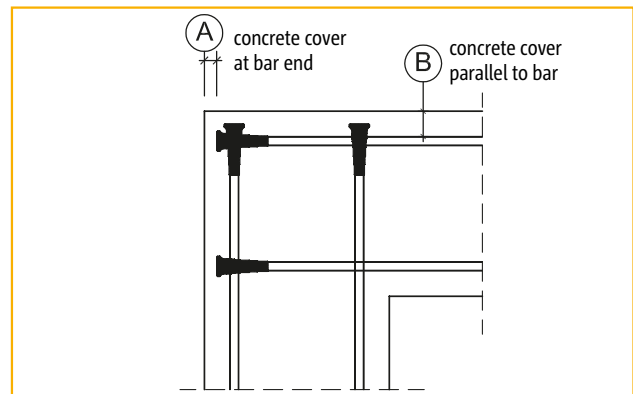
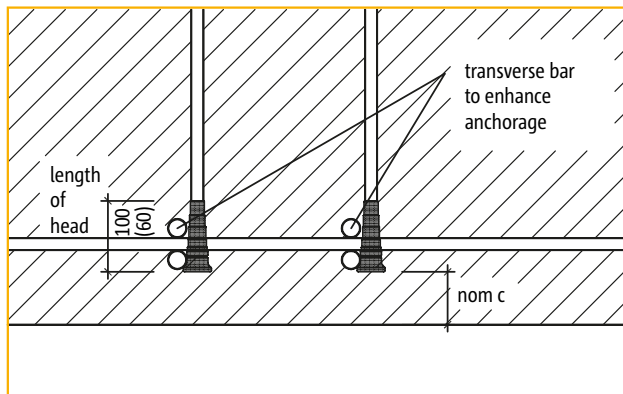

Schöck ComBAR®

Dowels

ComBAR® bars with and without ribs can be used as shear dowels to connect adjoining concrete elements (highway slabs, precast elements, etc.).

Tests were performed on ComBAR® dowels cast into concrete elements to determine their shear load capacity. It was shown that the load bearing capacity of the dowels is controlled by their interlaminar shear strength. Once this is exceeded cracks form in the dowel along its axis. These result in a reduction of the effective length of the dowel. The concrete along the face of the section is overloaded leading to concrete failure below the dowel.

The (long-term) design values for ComBAR® dowels were determined in durability tests performed at 60°C in highly alkaline concrete with a compressive strength of 35 MPa. This testing concept is analogous to the durability concept specified in the European general construction certifications of ComBAR® and adapted by the International Federation for Structural Concrete (fib).

Design values ComBAR® dowels (smooth bars)

df, dowel diameter [mm]	Af, dowel cross sectional area [mm ²]	V _d design value shear strength [kN]	l dowel, min. minimum length [mm]	c min min. concrete cover* [mm]	standard lengths [mm]
18.0	254	5.1	200	144	300
22.0	380	7.6	2 x 110 = 220	176	400
27.0	573	11.4	2 x 150 = 300	216	450
34.0	908	18.2	2 x 175 = 350	272	450

* values apply to reinforced elements only; min. cover for elements without reinforcement: 200 mm

Further test series are currently in progress. It is expected that they will yield higher design values than those shown above.

Installation detail

The concrete cover in concrete elements without reinforcement should be no less than 5 times the bar diameter (smallest value in laboratory tests).

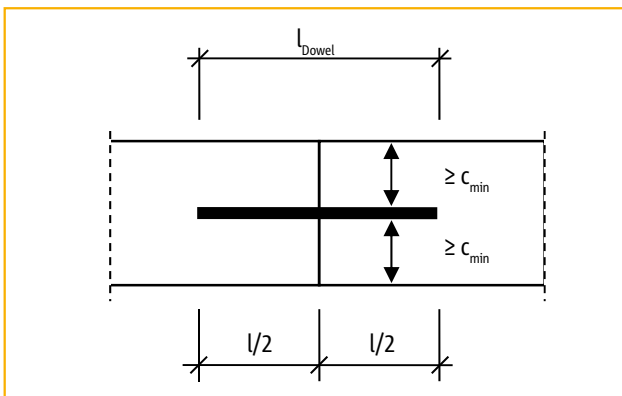

Schöck ComBAR®

Certifications and test reports

International certifications

Organisation, country	title	issue date
DIBt, Berlin, Germany	General construction authority permit Schöck ComBAR® Thermo Anchor	Nov. 2009 expanded Dec. 2011
DIBt, Berlin, Germany	General construction authority permit Schöck ComBAR® glass fibre reinforced polymer rebar; nominal diameter: \varnothing 16 mm	Dec. 2008 expanded June 2014
KOMO, KIWA, The Netherlands	ComBAR® glass fibre reinforcement in concrete \varnothing 8, 12, 16 mm	Feb. 2009
University of Toronto, Canada	Compliance of 16 mm ComBAR® GFRP bars with ISIS Canada Certification Specifications	Oct. 2007 Nov. 2010
Syracuse University, USA	Evaluation and Certification of GFRP bars ComBAR®; Tests with Respect to the Requirements of the ACI 440.R3-04 Report (12, 16 and 32 mm)	July 2006

Test reports and expert opinions

ComBAR® bars have been extensively tested by independent experts around the world and at the in-house laboratory of Schöck in conjunction with the certifications in Germany, in the Netherlands and in Canada. The majority of these tests was performed at the Schöck lab, which was specifically certified to perform them. These tests were monitored by independent experts.

Selected English language reports and expert opinions on tests of the material and mechanical properties of ComBAR® are listed below. These documents are available online at www.schoeck-combar.com. English summaries or translations of German language test reports will be provided upon request.

material property	title of report	author
human health and safety	Continuous Filament Glass Fibre and Human Health	European Glass Fibre Producers Association, APFE
chemical properties	Expert Report GFRP – Reinforcing Bars “ComBAR®”	University of Erlangen Dep. of Polymer Technology
behaviour in concrete	Expert Opinion regarding the application for a general construction authority permit for the GFRP reinforcement ComBAR®	Technical University Munich, Engineering Office Schiessl, Gehlen, Sodeikat, Munich
environmental impact	Categorisation of GFRP bars ComBAR® into the group Z0	Chemical Lab Dr. Vogt, Karlsruhe, Germany
tensile strength	Report on mechanical testing of GFRP rebars (8, 12, 16mm)	Arab Center for Engineering Studies, Doha, Qatar
fire performance	ComBAR® bond fire performance	Danish Technological Institute, Taastrup, Denmark
temperature dependence	Determination of temperature-dependent tensile strengths of ComBAR® reinforcement bars	Materials Testing Institute Braunschweig, Germany
durability	Durability and creep-rupture tests performed on straight GFRP bars with standard coating d=16mm	Schöck Bauteile GmbH (certification tests)

Schöck ComBAR®

Storage, transport and machining

Storage and transport

In general, high intensity long-term exposure to UV-rays can lead to the discoloration of polymers. After a prolonged (> 6 months) exposure the surface of the material becomes brittle. Unless special protective measures are undertaken, this results in the lasting deterioration of the polymers. As a result, Schöck ComBAR® should be covered and stored in a dry environment, especially when stored for longer time periods. Tests on bars that were stored outdoors for up to eight weeks without being protected, showed that climatic exposure in central Europe lead to a discoloration without causing a reduction of the bond or the tensile strength.

To avoid damage to the ribs, the material should not be dragged on the ground. It should not be subjected to abrasive forces.

When hoisted by crane, the deflection of ComBAR® bars is similar to that of steel bars of equal diameter. It is important that the appropriate cross beam/lifting equipment is used at all times.

Cutting

Cutting Schöck ComBAR® is significantly easier than cutting steel rebar. Either a hacksaw, band saw, or a grinder, using a diamond or a tough metal disc, is recommended. Both are fine enough to achieve a clean cut. ComBAR® bars should not be trimmed with bolt cutters or shears, as the glass fibres fray when the material is sheared off.

If desired, grates at the bar ends can be removed with a file or a rasp.

Because of the relatively low strength perpendicular to the glass fibres, ComBAR® bars should not be subjected to impact forces.

Bending

ComBAR® bars are linearly elastic up to failure. They can not be bent permanently (plastically). A bent bar returns to its original shape once the bending force is removed.

Small diameter ComBAR® bars can be bent into a radius as long as they are fixed in position while the concrete hardens. The stress induced in the bar by the bending process is to be added to the stress induced by the subsequently applied load. The total stress must not exceed the permissible value.

ComBAR® customised stirrups and bent bars are pre-fabricated at the factory.

Connection technology

Reinforcement cages made of Schöck ComBAR® bars are best assembled with ordinary **tying or coated wire**. Damage to the bars caused by properly installed tying wire is insignificant.

In cases where reinforcement cages are to be entirely free of steel, **plastic wire ties**, such as those used by electricians, can be used. A tightening wrench facilitates pulling and trimming of the ties.

Plastic clips have been developed to connect ComBAR® bars at ninety degree angles to form meshes. The clips are affixed to the bars using a rubber hammer or a similar tool. On a solid surface the clips can be affixed by stepping on them with the shoes. Clips are available for connections of 8 mm to 8mm and 12 mm to 12 mm bars.

Bar couplers, that are glued onto the Schöck ComBAR® bars in the factory, are an alternative means of connecting ComBAR® and steel bars. When the ComBAR® bars are screwed onto the steel bars, it is important that they are handled and turned at the connector, not at the bar. The glued couplers should not be exposed to temperatures above 100° C. Special care needs to be taken when welding in the vicinity of the couplers.

Wire rope grips can be used to connect Schöck ComBAR® bars to steel reinforcing bars. The ComBAR® bar should be placed in the curved form piece of the grip. Two short pieces of smaller diameter steel rebar should be placed in the grip, between the Schöck ComBAR® and the steel bar, to minimize the damage to the ComBAR® bar caused by the clamping force. When diameter 32 mm bars are connected, the torque applied to the nuts should not exceed 80 Nm. Special grips with wire rope clamp straps have been developed by Schöck for the connection of bars with a diameter greater than 32 mm.

application	description	project
industrial facilities and slabs	non-metallic reinforcement: <ul style="list-style-type: none"> ▶ no induction currents in the rebar ▶ un-disturbed operation of transportation systems 	
parking structures and garages	non-corrosive reinforcement: <ul style="list-style-type: none"> ▶ no crack-sealing coating required ▶ thin slabs 	
bridge decks, barrier walls, approach slabs, sidewalks, wing walls, curbs	non-corrosive reinforcement: <ul style="list-style-type: none"> ▶ no damages due to de-icing salts ▶ higher integrity and extended service life time of structure 	
railways	non-metallic reinforcement: <ul style="list-style-type: none"> ▶ no disturbance of signal systems ▶ no induction currents in the reinforcement near switches (induction coils) 	
marine structures	non-corrosive reinforcement: <ul style="list-style-type: none"> ▶ no damages due to sea water ▶ extended service life time 	
thin pre-cast elements and facade panels	non-corrosive reinforcement: <ul style="list-style-type: none"> ▶ minimum concrete cover sufficient ▶ minimal thickness 	
research facilities and ecological houses	non-metallic reinforcement: <ul style="list-style-type: none"> ▶ no creation or disturbance of electro-magnetic fields 	
masonry retrofitting	low modulus of elasticity: <ul style="list-style-type: none"> ▶ small stresses near anchor points due to temperature changes 	
civil engineering and infrastructure	machinable reinforcement: <ul style="list-style-type: none"> ▶ direct penetration by the tunnelling machine ▶ substantial reduction in construction costs 	

Schöck ComBAR®

Tensile strength and modulus of elasticity (straight bars)

In contrast to steel, Schöck ComBAR® behaves in a linear elastic manner up to failure. Yielding is not observed. The modulus of elasticity of straight bars is well above 60 GPa (64 GPa for \varnothing 16 mm bars). The mean value of the short term tensile strength measured in tensile tests on bare ComBAR® bars lies between 1,000 MPa (32 mm bars) and well above 1,500 MPa (8 mm). The true value is much higher, as the fibres themselves have a tensile strength of more than 3,000 MPa. With the volumetric fibre content of approximately 75% ComBAR® bars must have a short term tensile strength of approx. 2,200 MPa. The measured values are much lower, as the bars fail prematurely at the clamped ends and due to internal stresses being induced in the bars during the tests (eccentricity, application of force along the bar circumference only, etc.). As the long term strength of FRPs can not be derived from their short term strength, the meaning of the short term values for structural designs is minimal, anyhow.

bar diameter [mm]	mean value f_{tk} [N/mm ²]
8	1,500
12	1,350
16	> 1,200
20	> 1,150
25	> 1,100
32	> 1,000

Values from compliance tests University of Toronto

To determine the tensile strength and the stress-strain relationship both ends of Schöck ComBAR® bars are glued into shafts. The load is applied at approximately 1 kN/sec. in a hydraulic press. The modulus of elasticity is determined using highly sensitive strain gages. The diagram below shows the tensile test for a 16 mm bar.

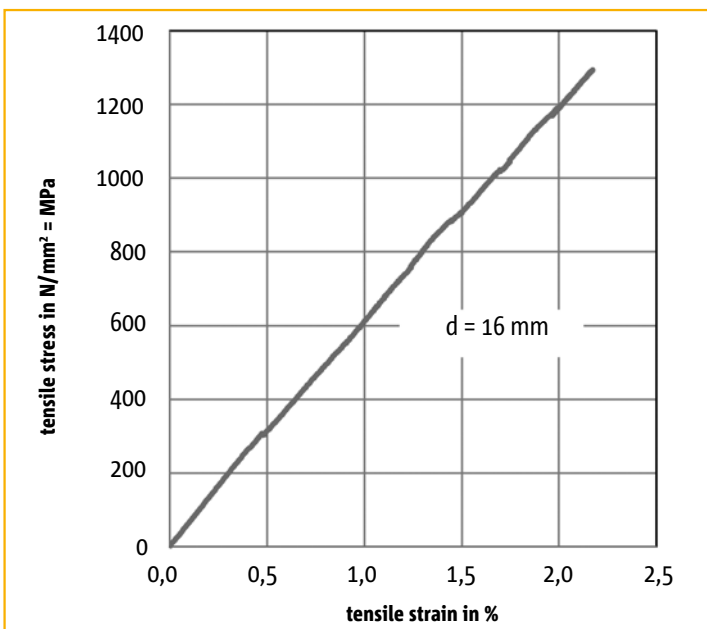

stress-strain diagram

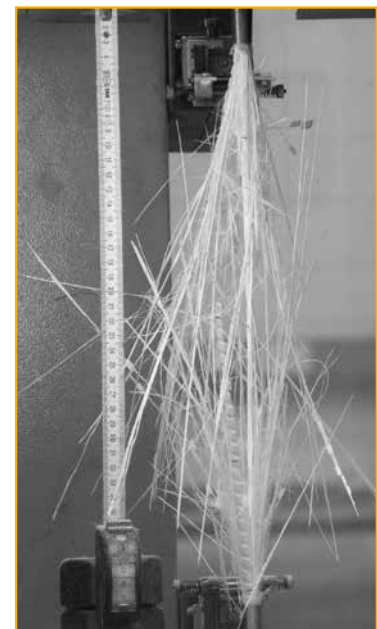

shredded bar

Failure is brittle. It occurs in the free span of the test specimen, when the tensile strength of the material is exceeded. The fibres burr in the fracture zone in a brush-like fashion. The outermost bar ends, where the specimen is fixed in the hydraulic press, including the ribs of the bars, are undamaged.

In contrast to the brittle failure of the test specimen, a ComBAR®-reinforced structural element shows distinct signs of the impending failure (large deflections and cracks) well in advance of reaching the ultimate strength.

Schöck ComBAR®

Durability, characteristic value of the tensile strength

Current international codes and guidelines on FRP reinforcement and the design of FRP reinforced concrete structures require durability tests on the basis of a residual strength approach (CSA, ACI, etc.). Bars are aged either under load or at relatively small loads ($\epsilon \leq 0.3\%$) in an alkaline solution for specified periods of time. After the aging process the bars are unloaded. Their residual tensile strength is tested in conventional tensile tests.

This approach was developed at a time when FRP rebars were primarily used as crack or secondary reinforcement and the stress levels in the bars were comparatively small. Newest generation FRP bars, such as Schöck ComBAR®, are able to sustain far higher stresses. Their bond properties are virtually analogous to those of steel reinforcement. Unlike steel, however, the long-term strength of FRPs decreases with time. The continuously sustainable tensile stress of FRPs is a function of the prevalent environmental conditions (mean temperature, amplitude of temperature changes, moisture / humidity level).

To allow for an economic utilisation of these bars a new safety concept had to be developed. This concept is needed to derive design values of the tensile strength for any specific environment and any specified design service lifespan. The central objective of the concept is to guarantee the same level of safety in any design of FRP reinforced concrete members while at the same time allowing for efficient and economic structures.

In this time-to-failure (creep rupture) approach the characteristic value of the tensile strength for a specific project is determined on the basis of the 1,000 hour strength f_{F1000h} of the chosen FRP material. f_{F1000h} is determined in tensile tests on bars cast into prisms of highly alkaline ($\text{ph} \geq 13.7$) concrete. The prisms are saturated with water and kept at a constant temperature over the entire duration of each test. f_{F1000h} is the stress in the bar which results in its failure after a load application over 1,000 hours.

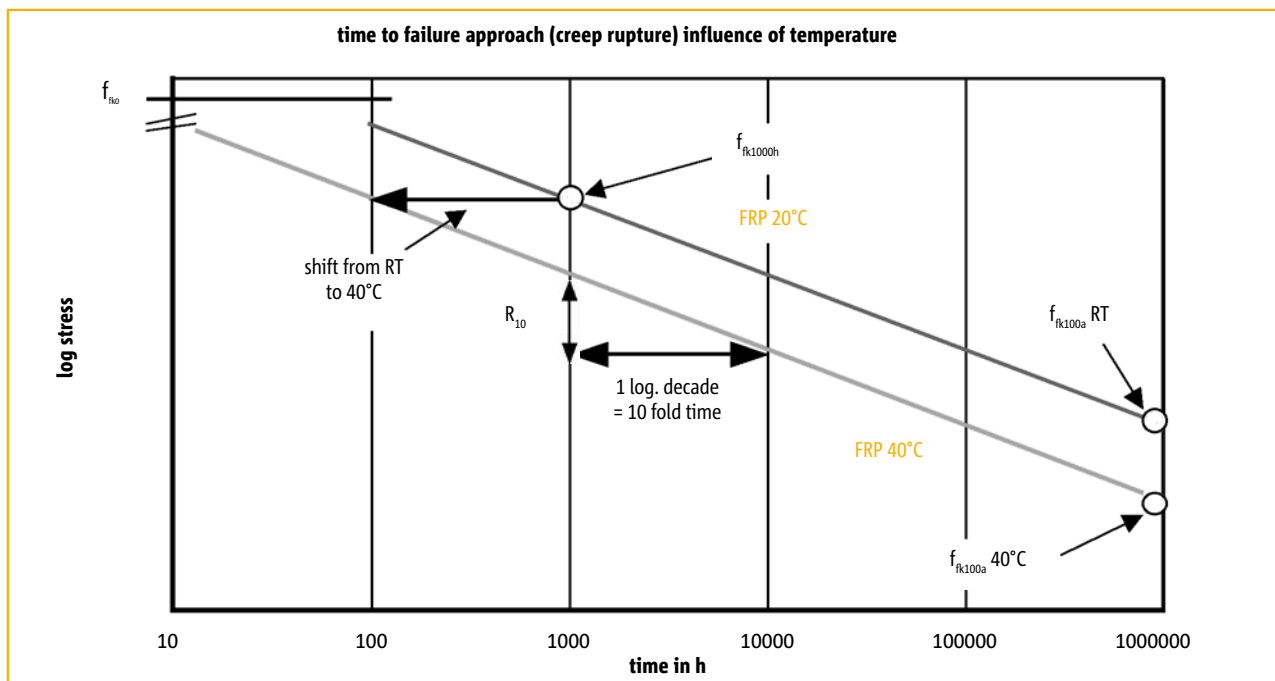

Relationship sustainable stress vs. time to failure (ComBAR®)

The characteristic value of the tensile strength $f_{Fk,t}$ for a specific set of environmental conditions and a specified design service life (t) is obtained by multiplying this value by the environmental factor η_{env} :

$$f_{Fk,t} = f_{fk1000h} * \eta_{env}$$

The environmental factor is defined as

$$\eta_{env} = [(100 - R_{10})/100]^n$$

Schöck ComBAR®

Durability, characteristic value of the tensile strength

where

R_{10} logarithmic temporal slope specified in a series of durability tests for each FRP material
While standard GFRPs have R_{10} values of 25%/dec and CFRP has 5%, R_{10} for ComBAR® is 15%/dec.

n environmental exponent $n = n_{mo} + n_T + n_{sl}$

n_{mo} moisture exponent

n_T effective temperature exponent

n_{sl} service life exponent

moisture condition	n_{mo}
dry	-1
outdoor	0
wet	1

effective temperature (C°)	n_T^*
10	0
20	0.5
23 (RT)	0.65
30	1.0
40	1.5
50	2.5
60	3.5

* intermediate values interpolated

design service life (years)	n_{sl}^*
100	3.0
50	2.7
20	2.3
10	2.0
5	1.7
1	1.0
0.1	0.0

* for resistance against accidental load
 $n_{sl} = 0.0$

The long-term strength of FRPs depends on both the maximum temperature and on the frequency and amplitude of the temperature changes where to the bar is exposed. These three effects are considered by defining the effective temperature and then selecting the corresponding effective temperature exponent n_T . The most feasible approach to determining the effective temperature is to add a margin of safety to the estimated mean annual temperature for the concrete structure. This temperature margin depends on the intensity of the exposure to the sun or an external heat source and on the thickness of the member.

location	environment	member thickness	temperature margin
indoor	constant room temperature (23 °C)	no influence	± 0°C
outdoor	direct exposure to sun, mostly dry	$h \geq 200\text{mm}$	+ 10°C
		$100 < h < 200\text{mm}$	+ 15°C
		$h \leq 100\text{mm}$	+ 20°C
	no direct exposure to sun, mostly dry	no influence	+ 10°C
wet / moist	fully submerged in water	no influence	+ 5°C
	frequently wet (tidal influence, splash water)	see outdoor	see outdoor
	embedded in soil	no influence	effective temp. = 10°C

All values for typical North-American / European environments

Characteristic values of the tensile strength of ComBAR® bars for common central European environmental conditions and for typical design service live spans are listed in Table 3 (page 34) of this technical information.

Schöck ComBAR®

Bond behavior (short-term)

Centric pull-out tests were performed on a 150 mm concrete cube, according to the RILEM RC 6 recommendations. The displacement at the unloaded end of the bar was plotted as a function of the load. The compressive strength of the concrete was $> 40 \text{ N/mm}^2$.

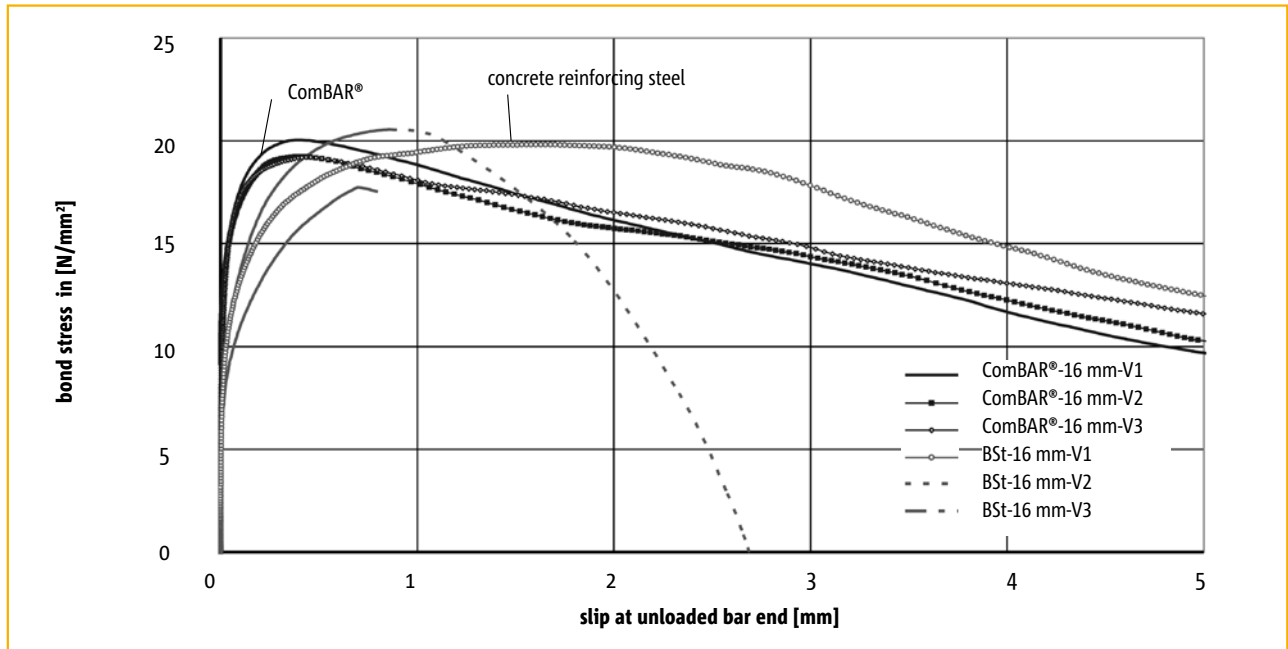

The results of the test series are:

- The failure mode is, as with steel rebar, extraction of the concrete corbels from the concrete block. The ribs of the rebar are largely undamaged.
- As is the case for reinforcing steel, higher bond stresses are observed in higher grade concrete.
- No significant differences were observed regarding the slip of the unloaded bar end of Schöck ComBAR® and steel bars. The maximum bond stress was recorded at a slip between 0.2 and 0.8 mm.
- Even though the bond stress of ComBAR® bars is greater at the same amount of slip, the tensile splitting forces are lower than those of steel rebar.
- Further bond tests have shown that, in normal grade concrete the bond behaviour of ComBAR® is controlled by the strength of the concrete corbels, in high strength concrete ($> 60 \text{ MPa}$ compr. strength) by the strength of the ComBAR® ribs.



The special surface profile of Schöck ComBAR® bars ensures optimal bond between concrete and the rebar.

Schöck ComBAR®

Bond behavior (long-term)

To determine the long-term bond behaviour and bond-creep behaviour of \varnothing 16 mm ComBAR® bars two series of bond test were run according to the RILEM recommendation RC6. The aim was to derive the bond behaviour of ComBAR® bars over a service life of 100 years on the basis of accelerated long-term tests under extreme conditions.

Bond-creep after pre-loading

To evaluate the bond-creep behaviour of ComBAR® bars in cracked, that is in pre-loaded, concrete members ComBAR® bars were cast centrally into 150 mm concrete cubes. The embedment length was five bar diameters $l_{b,net} = 5 d_f$. The cubes were cured in water at room temperature. In a first step the bars were loaded until the total slip at the loaded end was between 1 and 3 mm.

Subsequently a somewhat smaller permanent load was applied to the bars. For the entire duration of this second phase the concrete cubes were heated to 60°C and were kept completely saturated with water. At a constant bond stress of 11.2 MPa the additional slip at the loaded bar end was less than 0.6 mm after 2,000 hours. At a bond stress of 7.5 MPa it was less than 0.2 mm.

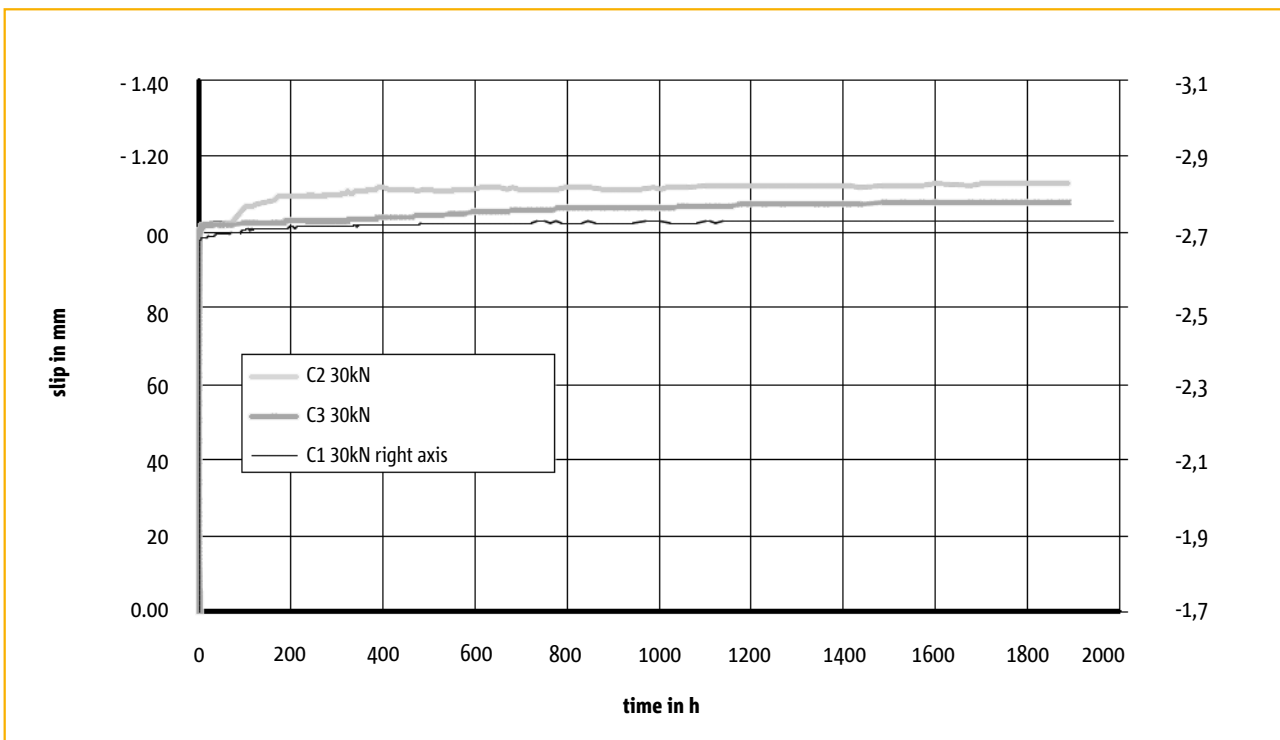

Bond-creep after pre-loading at $f_b = 7.5$ MPa; 60°C, constantly saturated concrete

Bond-creep without pre-loading

Without pre-loading bond stresses of 8 MPa could be sustained for 5000 hours (60°C, 10 ds embedment length).

Conclusions

- ▶ The long-term bond strength (100 year service life) is well above the required value of 8.0 MPa (ISIS Canada Specifications).
- ▶ At the required value of 8.0 MPa the total slip at the loaded end of the bar will be less than 0.3 mm.
- ▶ The bond coefficient k_b (CHBDC) can be taken to be 0.6, the bar surface factor $k_4 = 1.0$, and the bar surface profile factor (CSA S806) $k_s = 1.0$.
- ▶ The bond properties of bars with other diameters are equivalent to those of the 16 mm bar.

Schöck ComBAR®

Crack width

To determine the crack widths, tensile tests were carried out on cylindrical strain elements (Schöck ComBAR® $\varnothing = 16$ mm; concrete cover $c_v = 65$ mm; reinforcement ratio $\rho = 1,1$ %, concrete strength (cube) $f_{c,cube} = 30$ N/mm²). The strain elements did not contain any additional reinforcement. They were loaded up to a stress of 900MPa. Cracks appeared in the specimen once the tensile strength of the concrete was reached at a spacing of approximately 300 mm. As the load was increased, the width of the cracks increased. After the maximum load had been reached, the specimen was unloaded. The cracks closed nearly entirely. A detailed analysis of the specimen showed that the concrete corbels had sheared off in the vicinity of the cracks. Between the ribs of the bars the concrete corbels were intact. The bars did not show any signs of damage.

- Cracks appear in the specimen at intervals of approx. 300 mm, when the concrete tensile strength is reached. As the load is raised, the crack widths increase.
- The otherwise un-reinforced test strain body is loaded up to a stress of 900 N/mm².
- Entirely intact concrete corbels are seen in the middle sections of the fragments of the test specimen. In the vicinity of the cracks the concrete corbels have been sheared off.
- The bar, as well as its ribs, remain undamaged.



first crack (150 N/mm²)



second crack (300 N/mm²)



575 N/mm²



900 N/mm² (max. stress)



strain body after unloading

The results of the strain body tests allow for the following conclusions:

- The crack behaviour of ComBAR® is analogous to that of steel rebar.
- The distances between neighbouring cracks were generally smaller in reinforced concrete members with ComBAR® than they were in members with the same reinforcement ratio in steel.

Schöck ComBAR®

Crack width

The following approach can be taken to derive the approximately required cross sectional area of ComBAR® crack reinforcement from the required amount of steel rebar.

The crack width is proportional to the diameter of the rebar, independent of the reinforcing material which is used. If more bars of a smaller diameter are installed the cracks will be smaller.

As is the case for steel rebar, the total slip of ComBAR® bars (pull-out test) is proportional to the square of the stress in the bar. If the stress is reduced by half, the slip decreases to 25 %.

It can be conservatively assumed that the crack spacing is the same in a member reinforced with ComBAR® as it is in a steel reinforced section.

Based on these facts and assumptions the relationship between the required amount of ComBAR® bars and the required amount of steel rebar is:

$$\frac{W_{k, \text{ComBAR}^\circ}}{W_{k, \text{steel}}} = 1,0 = \frac{200.000 \text{ N/mm}^2}{60.000 \text{ N/mm}^2} \cdot \left[\frac{\varnothing_{\text{ComBAR}}}{\varnothing_{\text{steel}}} \right] \cdot \left[\frac{f_{\text{ComBAR}}}{f_{\text{steel}}} \right]$$

For equal bar diameters this implies:

$$\text{req. } A_{\text{ComBAR}^\circ} = \sqrt{\frac{200.000}{60.000}} A_{\text{steel}} = 1,83 A_{\text{steel}}$$

Schöck ComBAR®

Deflection

Deflection

The modulus of elasticity of ComBAR® is low compared to that of steel rebar ($E_F = 60\text{GPa}$). Therefore, special attention needs to be devoted to checking the serviceability limit state requirements.

In a lab test two concrete slabs of identical dimensions (2,500 x 1,000 x 200 mm), were tested in a four point bending test (bending zone without shear: 1,000 mm). Slab 1 was reinforced with 7 \varnothing 8 mm steel rebars (grade 500), slab 2 with 7 \varnothing 8 mm ComBAR®. The position and distribution of the bars were identical.

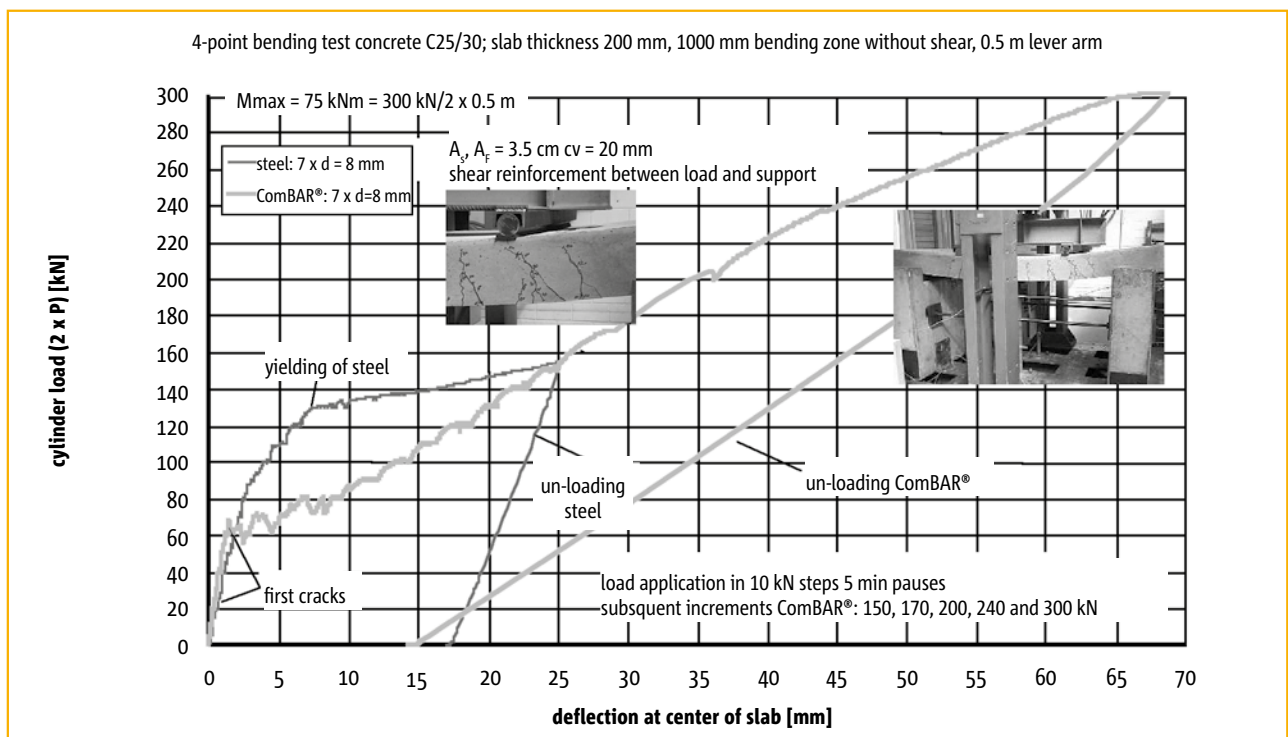

4-point bending test: comparison ComBAR® - steel

The maximum load sustained by the ComBAR® reinforced slab was more than twice as high as the load sustained by the steel reinforced slab. The maximum deflection was about three times as high.

Shortly after the first cracks formed the deflection of both slabs was nearly identical. After the service load was reached in the reinforcing bar (according to German codes approx. 305 MPa; 67kN cylinder load) the deflection of the ComBAR® reinforced slab was about 2.5 times greater. At 90% of this stress (60kN cylinder load) the difference of the deflections was between 1.5 and 2.0.

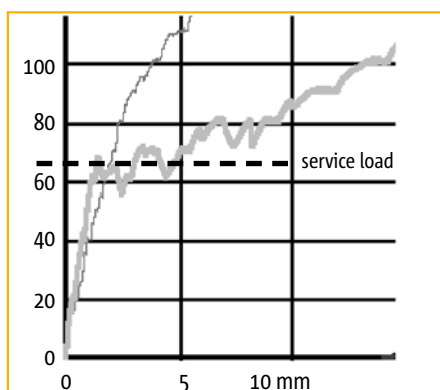

Excerpt 4-point bending test

Conclusions

- ▶ In any design of GFRP reinforced concrete members special attention needs to be paid to checking the deflection requirements.
- ▶ To achieve the same maximum deflection in a ComBAR® reinforced member as in the geometrically identical steel reinforced members approx. 2.5 times the reinforcement cross-section will be required.

Schöck ComBAR®

Thermal behaviour

Coefficient of thermal expansion

The axial and radial coefficient of thermal expansion were determined on test specimen at temperatures ranging from 0° C to 70° C.

Coefficient of thermal expansion α	Schöck ComBAR®
axial [1/K]	0.6×10^{-5}
radial [1/K]	2.2×10^{-5}

For comparison: the coefficient of thermal expansion of concrete is between 0.5 and 1.2×10^{-5} 1/K, that of reinforcing steel is 1.0×10^{-5} 1/K, that of stainless steel 1.5×10^{-5} 1/K.

Structural elements reinforced with Schöck ComBAR® are not affected by temperature changes. Expansive cracking did not occur in lab experiments, even when ComBAR® reinforcing bars were placed close to the surface of the specimen and the moisture content was varied over time. This can be explained by the relatively low modulus of elasticity of glass fibre rebars perpendicular to the bar axis. This is controlled by the modulus of the resin, which is between 3,000 and 5,000 MPa. A temperature increase of 40°C induces a strain of 0.088 %.

Ambient temperatures

The ambient temperature of ComBAR® bars within a concrete element should not exceed a sustained value of 40 °C. Unless noted otherwise, all technical values specified in the product data sheets were determined at room temperature. Higher temperatures which can occur during curing of massive concrete elements or regular temporary temperature values up to 65°C in facades, balconies or other thin elements do not cause any harm to the ComBAR® bars. A reduction of the load bearing capacity was not observed.

If ComBAR® bars are to be permanently exposed to higher temperatures, the characteristic value of the tensile strength is to be reduced according to the durability concept outlined on pages 17 and 18. The engineers at Schoeck are available for an in-depth consultation.

Behaviour at low temperatures

The behaviour of ComBAR® was tested at extremely low temperatures (up to -40 °C) in various test series in Canada according to ISIS specifications / CSA S807. It was shown that the material properties of ComBAR® remain nearly unchanged at extremely low temperatures.

Differential expansion of reinforcement and concrete

In certain critical situations the effects arising due to the fact that the coefficient of thermal expansion of the concrete is not the same as that of the reinforcement may have to be taken into account. The resulting stresses in the reinforcement due to an increase of the temperature of the RC member by 10°C are shown in N/mm² the table below.

reinforcement (modulus in GPa)	concrete (depending on aggregate)		
	$\alpha = 8$	$\alpha = 10$	$\alpha = 12$
carbon steel (E=200): $\alpha_{II} = 10$	4 N/mm ²	0	-4
ComBAR® (E=60): $\alpha_{II} = 6$	-1,2	-2,4	-3,6
stainless steel (E=160): $\alpha_{II} = 17$	14,4	11,2	8
CFRP (E=120): $\alpha_{II} = 0$	-9,6	-12	-14,4

Resulting stresses due to increase of 10°C coefficients of thermal expansion [in 10^{-6} 1/K]
tensile stresses negative!

Schöck ComBAR®

Fire resistance

The fire resistance of fibre composite materials is governed by the behaviour of the fibres and that of the resin. When exposed to an open flame a ComBAR® bar may catch on fire. It will stop burning after a short period of time when the flammable material at its surface has burned off. ComBAR® does not contain any fire retardants.

The tensile strength of the bar is controlled by the strength of the fibres which start to soften, i. e. melt, at about 600°C. The bond between the bar and the surrounding concrete is provided by the matrix. The matrix becomes softer as its temperature increases, thereby losing its bond strength. As this behaviour is distinctly different from that of steel reinforcement, it is recommended to limit the temperature of the bar in dependence with the bond strength in the load case “fire”. The critical temperatures for this procedure were determined at the IBMB Braunschweig in Germany. The critical temperatures, which vary only slightly for the different bar diameters, are failure temperatures. In the design the factor of safety on the material side is therefore 1.0.

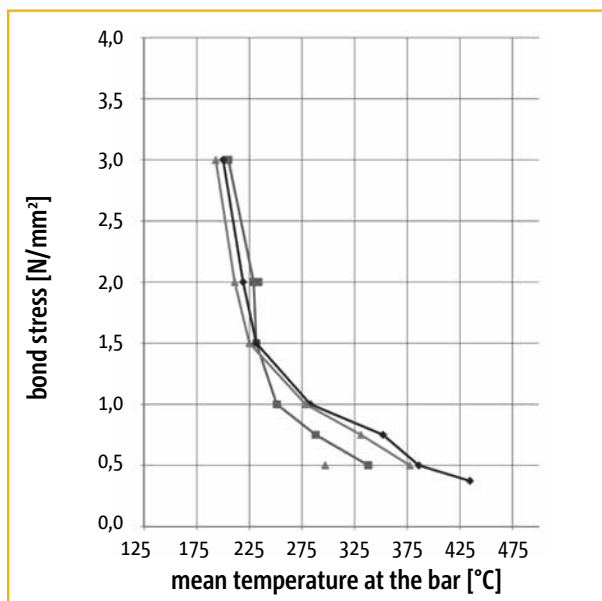

bond strength as a function of the mean temperature

When fire resistance is an issue measures have to be taken to insure that the surface temperature of the bars is not exceeded in the specified time period. The surface temperature of the bar may be taken as the temperature of the concrete at the center line of the bar.

bond strength (cold design) f_{fb} [N/mm ²]	critical temperature t [°C]
3,0	192
2,5	202
2,0	211
1,5	225
1,0	238
0,5	336

For different fire ratings either the minimum values of the concrete cover listed below have to be observed or other fire protection measures (such as fibre cement planking) have to be undertaken.

fire rating	concrete cover (min.) c [mm]
R30	30
R60	50
R90	65
R120	85

Schöck ComBAR®

Design concept

1. Loads and internal forces

Loads are determined in accordance with EC-1 and EC-2 or current national codes.

2. Internal forces

ComBAR® bars behave linearly elastic up to failure. Yielding is not observed. **Plastic hinges** do not form. As a result, the loads on GFRP reinforced concrete elements can not be determined using plastic limit analysis.

As cracked sections transfer increasingly larger loads, **moment redistribution** is observed only to a very limited extent in ComBAR® reinforced concrete members. Moment redistribution should, therefore, not be considered in the design.

For safety reasons **non-linear material properties** should not be considered in the design. They may be considered in the analysis of members and in the determination of deflections.

3. Design format

In the design it is to be shown that

$$E_d \leq R_d \quad \text{where } E_d \text{ are the design loads and } R_d \text{ is the design resistance.}$$

The material safety factor for ComBAR® is: $\gamma_f = 1.3$

4. Material properties concrete

Please refer to EC- 2 or current national codes.

5. Material properties ComBAR®

The material properties of ComBAR® bars are listed on pages 6 and 7 (straight bars), 8 and 9 (bent bars), 10 and 11 (bar end heads), 12 (dowels).

6. Exposure conditions and concrete cover

The exposure conditions listed in EC-2 or the relevant national codes apply to concrete without changes.

ComBAR® bars do not corrode. For all exposure conditions the minimum required concrete cover is, therefore:

$$c_{\text{nom}} = d_f + \Delta c \quad \text{where } \Delta c = 10 \text{ mm cast-in-place, } 5 \text{ mm pre-cast}$$

7. Bond properties

Bond conditions

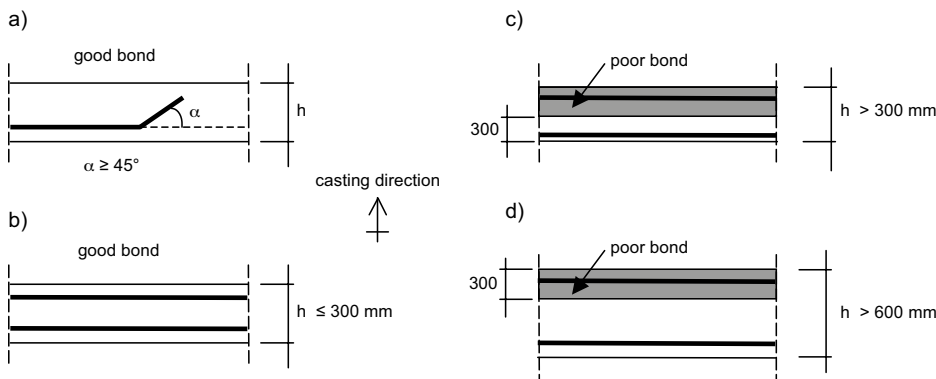

Design values bond stress straight ComBAR® bars [in N/mm ²]							
concrete grade	C20/25	C25/30	C30/37	C35/45	C40/50	C45/55	≥ C50/60
f_{bd} (good bond conditions)	2.03	2.26	2.33	2.39	2.45	2.51	2.58
f_{db} (poor bond conditions)	1.53	1.78	2.01	2.23	2.34	2.46	2.58

Schöck ComBAR®

Design concept

8. Development of bars

Development lengths of straight ComBAR® bars are to be determined according to EC-2 or the relevant national codes using the design values of the bond stress listed in section 7.

The development length of straight bars can be reduced by installing a bar with a headed end. ComBAR® headed ends transfer a load according to the table on page 10.

9. Bar splices

Splices of ComBAR® bars are designed and executed in the same manner as splices of conventional steel rebars are.

10. Bending design with/without normal loads

The design is performed by iteration of the strain plain under the same assumptions as those used in the design of steel reinforced concrete members. ComBAR® bars behave in a linearly elastic manner until failure.

The characteristic value of the long-term tensile strength is determined according to the procedure outlined on pages 17 and 18. Sample values for typical Central European environmental conditions are listed in Table 3 (page 34).

A design table for combinations of M and N is provided on pages 29 and 30 (Table 1). The design value of the tensile strength in this table is 435 N/mm², the same value as for steel rebar (acc. to DIN 1045-1 / EC-2).

11. Shear design

11.1 Design procedure

a) Additional terms for ComBAR® (in addition to terms in EC 2):

$V_{Rd,fd}$ design value of ComBAR® shear reinforcement

b) The required minimum reinforcement ratio specified in paragraph 9.3.2 (2) of EC 2 for beams and one-way slabs with $b/h < 5$ applies for ComBAR® as well.

c) In sections where $V_{Ed} > V_{Rd,c}$ ComBAR® stirrups and headed bolts are to be used as shear reinforcement.

11.2 Design values of the shear force

11.2.1 Members without shear reinforcement

a) Equation 6.2.a of EC 2 is modified for ComBAR® to:

$$V_{Rd,ct} \text{ bzw. } V_{Rd,c} = \frac{0,138}{\gamma_c} \cdot \kappa \cdot (100 \cdot \rho_l \cdot \frac{E_l}{E_s} \cdot f_{ck})^{1/3} \cdot b_w \cdot d$$

where $\beta = 3/(a/d) \geq 1,0$ magnification factor to account for loads located close to the support

$\kappa = 1 + \sqrt{200/d}$ size factor
 ρ_l longitudinal reinforcement ratio
 E_{fl} modulus of elasticity longitudinal reinforcement
 f_{ck} characteristic value concrete compressive strength
 b_w width of beam
 d structural depth

b) Equation 6.2 of EC 2 does not apply for ComBAR®.

Schöck ComBAR®

Design concept

11.2.2 Members with shear reinforcement

11.2.2.1 Simplified procedure

a) The strain in the ComBAR® shear reinforcement is limited to the same value as that in steel reinforcement: $\epsilon_f = \epsilon_s = 435 \text{ N/mm}^2 / 200,000 \text{ N/mm}^2 = 0,2175 \%$. This insures that the truss analogy according to EC 2 section 6.2.3 and Figure 6.5 is applicable to ComBAR®. Either ComBAR® stirrups or double headed bolts are used as shear reinforcement. The end heads are selected for a design value of the tensile strength of $f_{fd} = 130 \text{ N/mm}^2$. The shear reinforcement is to be anchored in the concrete compression zone. A concrete cover at the end heads (in the axis of the bars) is not required, they can be placed directly onto the formwork.

b) When using ComBAR® double headed bolts as shear reinforcement equation 6.9 of EC 2, for the determination of the design value $V_{Rd,fd}$ is modified to:

$$V_{Rd,fd} = \frac{A_{fw}}{S_w} \cdot f_{fd} \cdot z \cdot \cot \theta$$

11.2.2.2 Exact procedure according to Kurth and Hegger

In the journal paper „Shear Strength of Concrete Members with Fibre Composite Polymer Reinforcement - Derivation of a Design Approach“ [Bauingenieur Band 88, Oktober 2013] to M. Kurth and J. Hegger, a more exact, less conservative procedure for the determination of the shear strength of concrete members reinforced with ComBAR® bars is developed. It applies to sections containing longitudinal reinforcement only as well as to those containing longitudinal and shear reinforcement. In this procedure the load bearing capacity of the concrete and that of the shear reinforcement are added to obtain the overall load bearing capacity of the section.

$$V_{Rd} = V_{Rd,c} + V_{Rd,f}$$

The load bearing capacity of the shear reinforcement is:

$$V_{Rd,f} = \alpha_{fw} \cdot f_{fd,w} \cdot z \cdot \cot(\theta)$$

where α_{fw} cross sectional area ComBAR® shear reinforcement
 $f_{fd,w}$ design value tensile strength ComBAR® shear reinforcement ($f_{fd,w} \leq E_{fw} \cdot \epsilon_{fd,w}$)
 z internal lever arm
 θ inclination of concrete strut (= β)

and

$$\epsilon_{fd,w} = 2,3 + \frac{2 \cdot EI^* [\text{MNm}^2]}{30} \leq 7,0 [\%]$$

$$EI^* = E_{f1} \cdot A_{f1} (0,8 \cdot d)^2$$

$$\theta = \arctan \left[\sqrt[3]{\frac{M/V \cdot \alpha_{fw} \cdot E_{fw}}{A_{fl} \cdot E_{fl}}} \right] \left\{ \begin{array}{l} \geq 20^\circ \\ \leq 50^\circ \end{array} \right.$$

The design value of the shear strength may not exceed the maximum value $V_{Rd,max}$.

$$V_{Rd,max} = V_{Rd,c} + \frac{1,1 \cdot b_w \cdot z \cdot f_{cm}^{2/3}}{\gamma_c \cdot (\cot(\theta) + \tan(\theta))}$$

The correct moduli of elasticity are to be used for each type of reinforcement depending on whether straight ComBAR® bars with or without heads (60.000 N/mm²) or bent bars (50.000 N/mm²) are used.

The procedure according to Kurth and Hegger can be used for mixed reinforcement (e.g. longitudinal bars ComBAR®, stirrups steel).

Schöck ComBAR®

Design concept

12. Deflections

The modulus of elasticity of ComBAR® bars is substantially less than that of steel rebar. As a result, the behaviour in the serviceability limit state is often more critical in the design than it is in steel reinforced concrete members.

Typical reinforcement ratios required to limit the deflection of a single span slab to $L/250$ are provided in Table 4 (page 35).

13. Crack control

Crack widths should be limited to no more than 0.7mm (internal members) and 0.5mm (exterior members).

A detailed proof according to EC-2 is to be performed using

$$S_{r,\max} = \frac{d_f}{2.8 \cdot \text{eff } \rho_f} \leq \frac{\sigma_f d_f}{2.8 \cdot f_{ct,\text{eff}}}$$

Required reinforcement cross sections to limit the crack widths to specific values can be determined using Chart 1 (page 32). Similar tables for other commonly used concrete grades are available on the Schöck web site.

Table 1: Omega-table for design in ULS

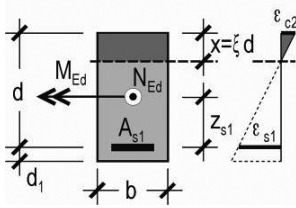

$$M_{Ed1} = M_{Ed} - N_{Ed} \cdot z_{s1}$$

$$\mu_{Ed1} = M_{Ed1} / (b \cdot d^2 \cdot f_{cd})$$

$$\text{erf. } A_s = (\omega_1 \cdot b \cdot d \cdot f_{cd} + N_{Ed}) / f_{yd}$$

μ_{Ed1}	ω_1	ξ	ζ	ϵ_{c2} ‰	ϵ_{s1} ‰	f_{yd} N/mm ²	μ_{Ed1}
0,001	0,001	0,017	0,994	-0,123	7,250	435,000	0,001
0,002	0,002	0,024	0,992	-0,175	7,250	435,000	0,002
0,003	0,003	0,029	0,990	-0,217	7,250	435,000	0,003
0,004	0,004	0,034	0,989	-0,252	7,250	435,000	0,004
0,005	0,005	0,038	0,987	-0,283	7,250	435,000	0,005
0,006	0,006	0,041	0,986	-0,311	7,250	435,000	0,006
0,007	0,007	0,045	0,985	-0,338	7,250	435,000	0,007
0,008	0,008	0,048	0,984	-0,363	7,250	435,000	0,008
0,009	0,009	0,051	0,983	-0,387	7,250	435,000	0,009
0,010	0,010	0,053	0,982	-0,409	7,250	435,000	0,010
0,011	0,011	0,056	0,981	-0,431	7,250	435,000	0,011
0,012	0,012	0,059	0,980	-0,452	7,250	435,000	0,012
0,013	0,013	0,061	0,979	-0,472	7,250	435,000	0,013
0,014	0,014	0,063	0,978	-0,491	7,250	435,000	0,014
0,015	0,015	0,066	0,978	-0,510	7,250	435,000	0,015
0,016	0,016	0,068	0,977	-0,529	7,250	435,000	0,016
0,017	0,017	0,070	0,976	-0,547	7,250	435,000	0,017
0,018	0,018	0,072	0,975	-0,564	7,250	435,000	0,018
0,019	0,020	0,074	0,975	-0,582	7,250	435,000	0,019
0,020	0,021	0,076	0,974	-0,598	7,250	435,000	0,020
0,025	0,026	0,086	0,971	-0,679	7,250	435,000	0,025
0,030	0,031	0,094	0,967	-0,753	7,250	435,000	0,030
0,035	0,036	0,102	0,965	-0,824	7,250	435,000	0,035
0,040	0,042	0,110	0,962	-0,892	7,250	435,000	0,040
0,045	0,047	0,117	0,959	-0,957	7,250	435,000	0,045
0,050	0,052	0,123	0,957	-1,021	7,250	435,000	0,050
0,055	0,058	0,130	0,954	-1,083	7,250	435,000	0,055
0,060	0,063	0,136	0,952	-1,143	7,250	435,000	0,060
0,065	0,068	0,142	0,950	-1,203	7,250	435,000	0,065
0,070	0,074	0,148	0,947	-1,262	7,250	435,000	0,070
0,075	0,079	0,154	0,945	-1,321	7,250	435,000	0,075
0,080	0,085	0,160	0,943	-1,379	7,250	435,000	0,080
0,085	0,090	0,165	0,941	-1,437	7,250	435,000	0,085
0,090	0,096	0,171	0,938	-1,495	7,250	435,000	0,090
0,095	0,101	0,176	0,936	-1,552	7,250	435,000	0,095
0,100	0,107	0,182	0,934	-1,610	7,250	435,000	0,100
0,105	0,113	0,187	0,932	-1,669	7,250	435,000	0,105
0,110	0,118	0,192	0,929	-1,727	7,250	435,000	0,110

Schöck ComBAR®

Table 1 (continued)

μ_{Ed1}	ω_1	ξ	ζ	ϵ_{c2} ‰	ϵ_{s1} ‰	f_{yd} N/mm ²	μ_{Ed1}
0,115	0,124	0,198	0,927	-1,787	7,250	435,000	0,115
0,120	0,130	0,203	0,925	-1,847	7,250	435,000	0,120
0,125	0,136	0,208	0,922	-1,908	7,250	435,000	0,125
0,130	0,141	0,214	0,920	-1,969	7,250	435,000	0,130
0,135	0,147	0,219	0,918	-2,032	7,250	435,000	0,135
0,140	0,153	0,224	0,915	-2,096	7,250	435,000	0,140
0,145	0,159	0,230	0,913	-2,162	7,250	435,000	0,145
0,150	0,165	0,235	0,910	-2,229	7,250	435,000	0,150
0,160	0,177	0,246	0,905	-2,367	7,250	435,000	0,160
0,170	0,189	0,257	0,899	-2,512	7,250	435,000	0,170
0,180	0,201	0,269	0,894	-2,663	7,250	435,000	0,180
0,190	0,214	0,280	0,888	-2,822	7,250	435,000	0,190
0,200	0,227	0,292	0,882	-2,989	7,250	435,000	0,200
0,210	0,240	0,304	0,876	-3,164	7,250	435,000	0,210
0,220	0,253	0,316	0,870	-3,348	7,250	435,000	0,220
0,228	0,264	0,326	0,865	-3,500	7,250	435,000	0,228
0,240	0,280	0,346	0,856	-3,500	6,605	396,000	0,240
0,250	0,295	0,364	0,849	-3,500	6,118	367,000	0,250
0,260	0,309	0,382	0,841	-3,500	5,666	340,000	0,260
0,270	0,324	0,400	0,834	-3,500	5,247	315,000	0,270
0,280	0,339	0,419	0,826	-3,500	4,856	291,000	0,280
0,290	0,355	0,438	0,818	-3,500	4,490	269,000	0,290
0,300	0,371	0,458	0,810	-3,500	4,146	249,000	0,300
0,310	0,387	0,478	0,801	-3,500	3,823	229,000	0,310
0,320	0,404	0,499	0,793	-3,500	3,517	211,000	0,320
0,330	0,421	0,520	0,784	-3,500	3,228	194,000	0,330
0,340	0,439	0,542	0,774	-3,500	2,953	177,000	0,340
0,350	0,458	0,565	0,765	-3,500	2,692	162,000	0,350
0,360	0,477	0,589	0,755	-3,500	2,442	147,000	0,360
0,370	0,497	0,614	0,745	-3,500	2,203	132,000	0,370
0,380	0,518	0,640	0,734	-3,500	1,973	118,000	0,380
0,390	0,540	0,667	0,723	-3,500	1,751	105,000	0,390
0,400	0,563	0,695	0,711	-3,500	1,535	92,000	0,400

Schöck ComBAR®

Table 2: Reinforcement for specified wk (C25/30)

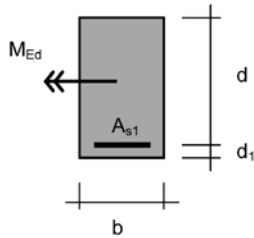

$$\mu_{ek} = \frac{M_{Ed}}{Md^2 f_{ck}} \frac{d_1/d}{d_1/w_k} \quad A_{s1} = \rho_1 \cdot bd$$

C25 - 100p₁

d ₁ /d	0,10				0,15				0,20			
	d ₁ /w _{zul} 20	40	60	80	20	40	60	80	20	40	60	80
0,010	0,118	0,168	0,206	0,239	0,118	0,168	0,206	0,239	0,118	0,168	0,206	0,239
0,012	0,142	0,202	0,248	0,288	0,142	0,202	0,248	0,288	0,142	0,202	0,248	0,288
0,014	0,166	0,237	0,291	0,337	0,166	0,237	0,291	0,337	0,166	0,237	0,291	0,337
0,016	0,191	0,271	0,333	0,386	0,191	0,271	0,333	0,386	0,191	0,271	0,333	0,386
0,018	0,215	0,305	0,376	0,435	0,215	0,305	0,376	0,435	0,215	0,305	0,376	0,435
0,020	0,239	0,340	0,418	0,484	0,239	0,340	0,418	0,484	0,239	0,340	0,418	0,484
0,022	0,263	0,375	0,461	0,534	0,263	0,375	0,461	0,534	0,263	0,375	0,461	0,534
0,024	0,288	0,410	0,504	0,584	0,288	0,410	0,504	0,584	0,288	0,410	0,504	0,584
0,026	0,307	0,435	0,534	0,617	0,321	0,444	0,547	0,634	0,321	0,444	0,547	0,634
0,028	0,326	0,462	0,567	0,655	0,337	0,479	0,590	0,684	0,337	0,479	0,590	0,684
0,030	0,344	0,488	0,598	0,692	0,355	0,503	0,616	0,712	0,360	0,511	0,626	0,724
0,032	0,362	0,513	0,628	0,726	0,374	0,530	0,649	0,750	0,377	0,535	0,655	0,757
0,034	0,378	0,536	0,657	0,759	0,392	0,555	0,681	0,786	0,396	0,561	0,688	0,795
0,036		0,558	0,685	0,791	0,409	0,580	0,711	0,821	0,414	0,587	0,719	0,831
0,038		0,580	0,711	0,822		0,604	0,740	0,855		0,611	0,749	0,865
0,040		0,601	0,737	0,851		0,626	0,768	0,887		0,634	0,778	0,899
0,042		0,621	0,761	0,880		0,648	0,795	0,918		0,657	0,806	0,931
0,044		0,640	0,785	0,908		0,669	0,821	0,948		0,679	0,832	0,962
0,046			0,809	0,935			0,846	0,977		0,700	0,858	0,992
0,048			0,831	0,961			0,870	1,006			0,884	1,021
0,050			0,853	0,987			0,894	1,033			0,908	1,050
0,052				1,012				1,060			0,932	1,077
0,054				1,036				1,086				1,104
0,056												1,131

Schöck ComBAR®

Chart 1: Minimum reinforcement for given value of w_{zul}

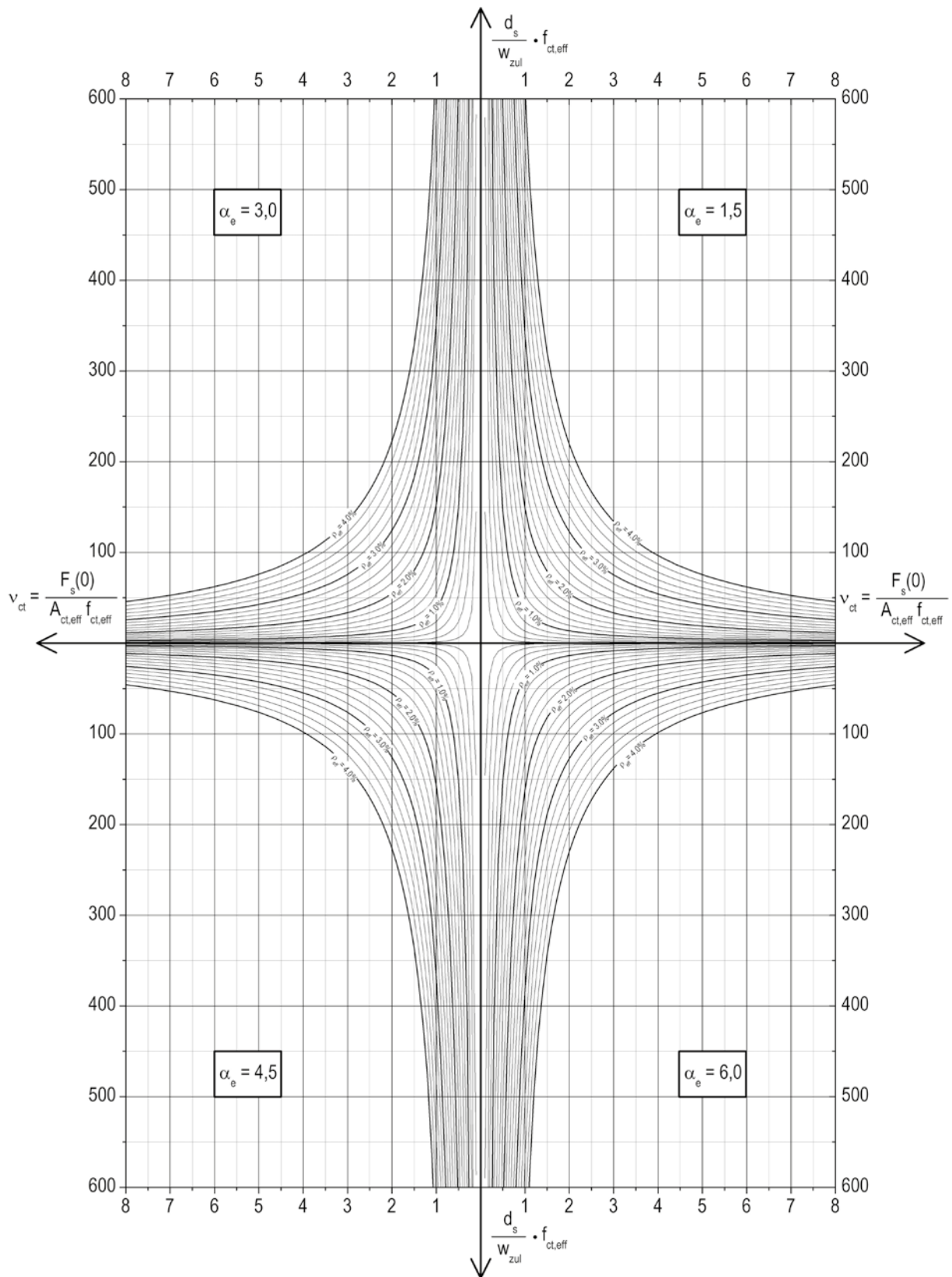

Chart 1: Minimum reinforcement for given value of w_{zul} horizontal

Schöck ComBAR®

Chart 2: Crack control reinforcement for $M_{Ed} + N_{Ed}$ (C 25/30; $d/h = 0,10$)

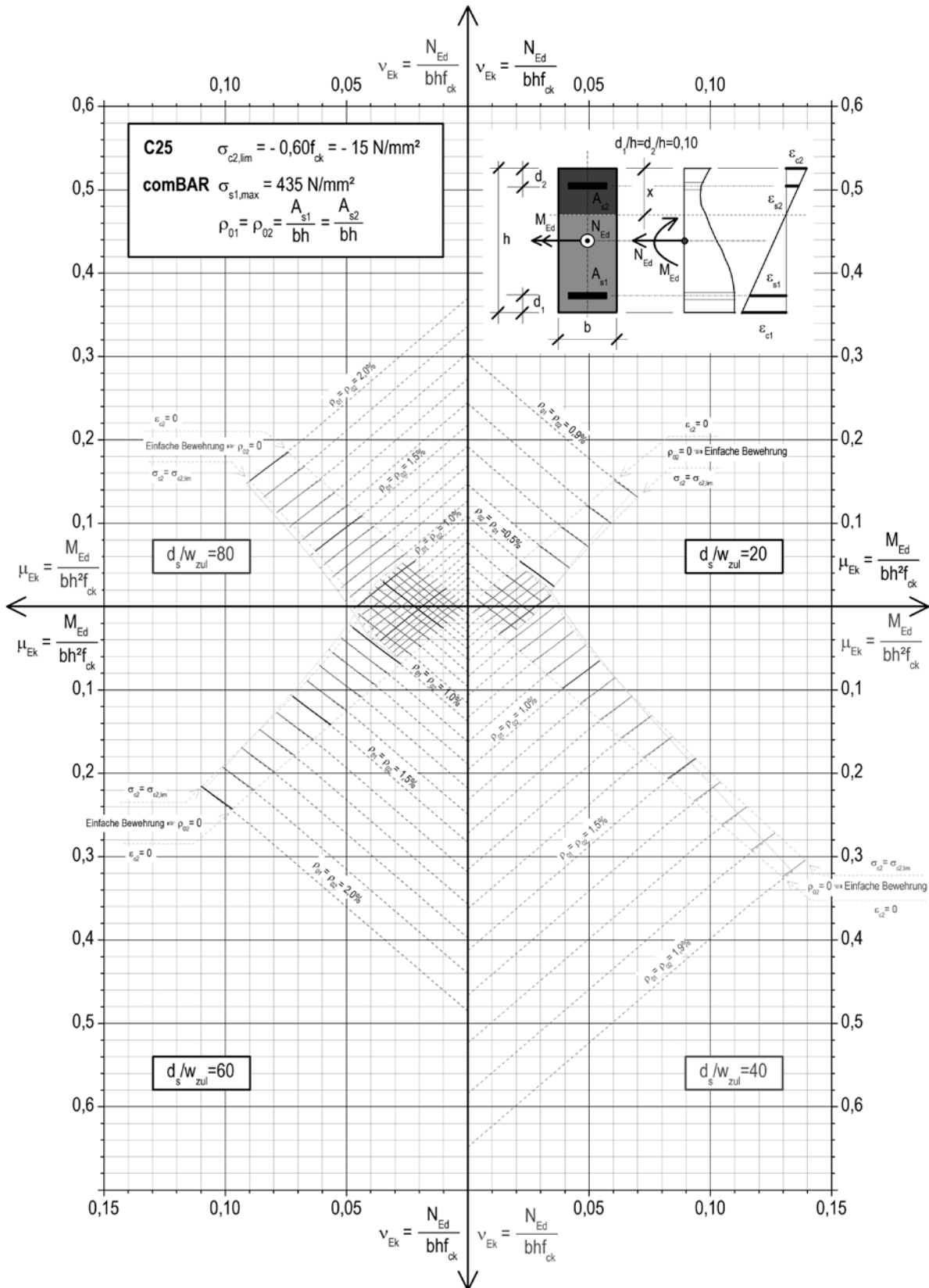

Chart 2: Crack control reinforcement for $M_{Ed} + N_{Ed}$; C 25/30; $d/h = 0,10$

Schöck ComBAR®

Table 3: Characteristic values long-term tensile strength ComBAR®

The values in this table were determined according to the durability concept explained on pages 17 and 18.

Mean Annual Temperature: 10° C (typical Central European conditions)

application	design serv. life [years]	environment	thickness (h)	effect. temp.	n	η_{env}	$f_{Fk,t}$ [MPa]
diaphragm wall	5	wet	1000 mm	10 °C	2.7	0.64	612
industrial floor slab	100	indoor, const. temp.	150 mm	23 °C	2.65	0.65	617
retaining wall	100	outdoor, direct sun	400 mm	20 °C	3.5	0.57	537
bridge deck	100	outdoor, direct sun	150 mm	25 °C	3.75	0.55	516
façade element	100	outdoor, direct sun	60 mm	30 °C	4.0	0.52	495
underside of bridge	100	outdoor, direct sun	250 mm	20 °C	3.5	0.57	537
sea wall	100	wet	500 mm	20 °C	4.5	0.48	457
impact on barrier wall	0.1	outdoor, direct sun	> 200 mm	20°C	1.0	0.85	807

Schöck ComBAR®

Table 4: Required reinforcement for a deflection of L/250

Single span slab with uniform load

slab width: 1,000 mm
 concrete: grade 30
 live load: 3.5 kN/m²
 sustained load: dead load + 0.3 x live load

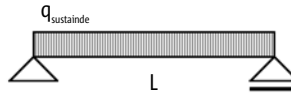

A [cm ²] tensile stress [MPa]	h [mm]				
L [m] L/250 [mm]	160	180	200	250	300
3.5 m 14 mm	6.3 cm ² 205 MPa	2.1 cm ²	2.3 cm ²	2.8 cm ²	3.3 cm ²
4.0 m 16 mm	16.3 cm ² 107 MPa	11.5 cm ² 138 MPa	6.6 cm ² 227 MPa	2.8 cm ²	3.3 cm ²
4.5 m 18 mm	23.2 cm ² 89 MPa	17.0 cm ² 120 MPa	13.0 cm ² 147 MPa	6.2 cm ² 271 MPa	3.3 cm ²
5.0 m 20 mm		28.1 cm ² 89 MPa	21.4 cm ² 111 MPa	12.3 cm ² 169 MPa	6.7 cm ² 285 MPa
5.5 m 22 mm			32.6 cm ² 89 MPa	21.5 cm ² 120 MPa	14.0 cm ² 169 MPa
6.0 m 24 mm		$\rho > 2\%$		35.2 cm ² 85 MPa	23.2 cm ² 120 MPa

min. reinforcement according to German certification; concrete cover = 15 mm; $d_{bar} = 12$ mm

reinforcement ratio $> 2\%$ (not economical)

Schöck ComBAR®

Table 5.a: Elastic bending of ComBAR® bars

ComBAR® bars can be bent elastically, for instance to create round stirrups for drilled piles or to fit the bars into the vault of a tunnel. The bent bars have to be fixed in their position. Once the force applied to bend the bar is removed the bar returns to its original straight shape.

Bending the bars induces tensile and compressive stresses. The total tensile stress from pre-bending the bar and from additional applied loads may not exceed the allowable tensile strength.

$$\varepsilon_{\text{pre-bending}} = \frac{d_{1/2}}{R} \quad f_{\text{pre-bending}} = \varepsilon_{\text{pre-bending}} \cdot E_r$$

Table 5.a: Stresses induced in the bar by pre-bending / residual stress which can be induced into the bar by additional loads. Minimum bending diameters (at $f_{fd} = 445 \text{ N/mm}^2$) are highlighted

bending radius	d = 8 mm		d = 12 mm		d = 16 mm		d = 20 mm		d = 25 mm		d = 32 mm		bending radius
	$f_{\text{pre-bend}}^*$	allow f_{load}^{**}	$f_{\text{pre-bend}}$	allow f_{load}	$f_{\text{pre-bend}}$	allow f_{load}	$f_{\text{pre-bend}}$	allow f_{load}	$f_{\text{pre-bend}}$	allow f_{load}	$f_{\text{pre-bend}}$	allow f_{load}	
0.54 m	445	0											0,54 m
0.75 m	320	125											0.75 m
0.81 m			445	0									0.81 m
1.00 m	240	205	360	85									1.00 m
1.08 m					445	0							1.08 m
1.20 m	200	245	300	145	400	45							1.20 m
1.35 m							445	0					1.35 m
1.50 m	160	285	240	205	320	125	400	45					1.50 m
1.69 m									445	0			1.69 m
2.00 m	120	325	180	265	240	205	300	145	375	70			2.00 m
2.16 m											445	0	2.16 m
3.00 m	80	365	120	325	160	285	200	245	250	195	320	125	3.00 m
5.00 m	48	397	72	373	96	349	120	325	150	295	192	253	5.00 m
7.50 m	32	413	48	397	64	381	80	365	100	345	128	317	7.50 m
10.00 m	24	421	36	409	48	397	60	385	75	370	96	349	10.00 m
15.00 m	16	429	24	421	32	413	40	405	50	395	64	381	15.00 m
20.00 m	12	433	18	427	24	421	30	415	38	408	48	397	20.00 m
25.00 m	10	435	14	431	19	426	24	421	30	415	38	407	25.00 m
30.00 m	8	437	12	433	16	429	20	425	25	420	32	413	30.00 m

* $f_{\text{pre-bend}}$ = stress due pre-bending

** allow f_{load} = allowable additional stress due load

Intermediate values may be interpolated!

Schöck ComBAR®

Table 5b: Elastic bending of ComBAR® bars

The force required to bend ComBAR® bars can be determined by using the laws of technical mechanics. For bars supported at both ends (single span) the forces required to bend the bars into specific radii are shown in Table 5.b.

$$P = \frac{48EI\delta}{s^3} \quad \text{mit} \quad I = \frac{r^4\pi}{4}$$

$$s = 2R \quad \sin \frac{\alpha}{2}$$

$$h = 0,5s \quad \tan \frac{\alpha}{4}$$

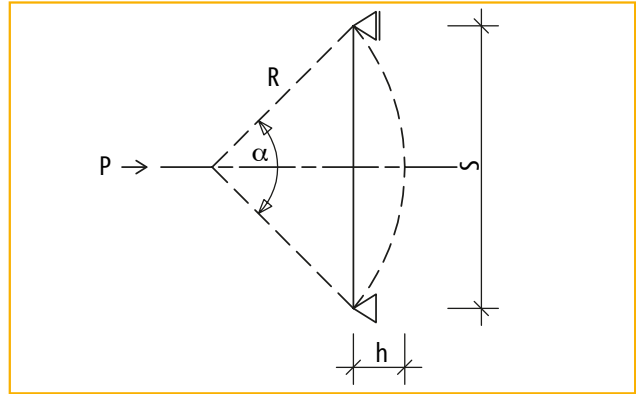

Table 5.b: Forces (exemplary) required to bend ComBAR bars into specific radii. Minimum bending radii are highlighted.

	R [m]	s [m]	α [RAD]	h [mm]	P[N]
8	0.54	1.00	2.37	337	195
12	0.81	1.50	2.37	506	439
16	1.08	2.00	2.37	674	781
20	1.50	2.00	1.46	382	1080
25	2.50	3.00	1.29	500	1023
32	6.00	3.00	0.51	191	1046

Schöck ComBAR®

Specifications

no.	description	quantity	unit	unit price in EUR	total price in EUR
1.	Sample Project				
1.10.	Non-metallic reinforcement made of glass fibre reinforced polymer incl. associated services				
1.10.10.	Schöck ComBAR® straight bars Straight bars made of durable, high-strength, corrosion resistant glass fibre reinforced polymer. Certified in Germany and The Netherlands. Minimum tensile strength: > 1000 N/mm ² (according to ACI, CSA guidelines and standards), M. o. E. ≥ 60,000 N/mm ² . Bond properties equivalent to steel rebar. Durability under load tested for 100 years. Bar lengths up to 11.80 m (sea freight) or 14 m (truck load without surcharge for over-length). Product: Schöck ComBAR®				
1.10.10.10.	Straight bars diameter 8 mm				
1.10.10.20.	Straight bars diameter 12 mm				
1.10.10.30.	Straight bars diameter 16 mm				
1.10.10.40.	Straight bars diameter 20 mm				
1.10.10.50.	Straight bars diameter 25 mm				
1.10.10.60.	Straight bars diameter 32 mm				
1.10.20.	Schöck ComBAR® single headed bolts Single headed bolts made of durable, high-strength, corrosion resistant glass fibre reinforced polymer. Straight ComBAR® bars with one end head made of injection molded polymeric concrete. To reduce the development length at one end of the bar. E ≥ 60,000 N/mm ² . Bar end heads are applied at the factory. Lengths from 0.1 m (∅ 12 mm) to 4.5 m (longer bars on request). Product: Schöck ComBAR®				
1.10.20.10.	single headed bolt diameter 12 mm				
1.10.20.20.	single headed bolt diameter 16 mm				
1.10.20.30.	single headed bolt diameter 20 mm				
1.10.20.40.	single headed bolt diameter 25 mm				
1.10.20.50.	single headed bolt diameter 32 mm				
1.10.30.	Schöck ComBAR® double headed bolts Double headed bolts made of durable, high-strength, corrosion resistant glass fibre reinforced polymer. Straight ComBAR® bars with two end heads made of injection molded polymeric concrete. To reduce the development length at both ends of the bar, as shear or punching shear reinforcement. E ≥ 60,000 N/mm ² . Bar end heads are applied at the factory. Lengths from 0.16 m (∅ 12 mm) to 4.5 m (longer bars on request). Product: Schöck ComBAR®				
1.10.30.10.	double headed bolt diameter 12 mm				
1.10.30.20.	double headed bolt diameter 16 mm				
1.10.30.30.	double headed bolt diameter 20 mm				
1.10.30.40.	double headed bolt diameter 25 mm				
1.10.30.50.	double headed bolt diameter 32 mm				

Schöck ComBAR®

Specifications

no.	description	quantity	unit	unit price in EUR	total price in EUR
1.10.40.	Schöck ComBAR® bent bars / stirrups Bent bar or stirrup made of durable, high-strength, corrosion resistant glass fibre reinforced polymer. $E \geq 50,000 \text{ N/mm}^2$. 2D and 3D possible; bents in any direction. Bars are bent at the factory. Lengths from 0.2 m (\varnothing 12 mm) to 6.5 m; dimensions up to 1.95 x 3.15 m. Product: Schöck ComBAR®				
1.10.40.10.	bent bars / stirrups diameter 12 mm				
1.10.40.20	bent bars / stirrups diameter 16 mm				
1.10.40.30.	bent bars / stirrups diameter 20 mm				
1.10.50.	ComBAR® accessories				
1.10.50.10.	bar clips 8 / 8 mm Plastic clips to connect ComBAR® bars in a 90° angle. Shipping unit 1000 clips.				
1.10.50.20.	bar 12 /12 mm ibid Shipping unit 500 clips				
1.10.50.30.	plastic cable ties L = 292 mm				
1.10.50.40.	plastic mesh pipe rebar spacer Rebar spacer made of plastic mesh pipe; diameter 140 mm. 2.0 m long; to be cut at the site.				
1.10.50.50.	Wire rope grips (steel) for cage assembly Steel wire rope grips 34mm. Analogous DIN 741 to connect a 32 mm ComBAR® bar and a steel rebar. Hand sorted.				
1.10.60.	Accompanying services				
1.10.60.10.	Site attendance and personell training Attendance at the installation and instruction of personnell into proper handling of ComBAR®. Including normal allowances. Travel expenses are billed separately.				
1.10.60.20.	Structural design Structural design of ComBAR® reinforced elements for release by the supervising engineer on the basis of information regarding the applicable codes and guidelines, the geometry, the concrete strength, the internal forces and all other significant constraints which are to be considered. Priced on cost-plus basis.				
1.10.60.30.	Reinforcement drawings Reinforcement drawings of the ComBAR® reinforced elements on the basis of a final structural design (released by the responsible parties) including sections, material lists, details of the connections. Priced per rebar drawing DIN A0				

Imprint

Editor: Schoeck Bauteile GmbH
Vimbucher Straße 2
76534 Baden-Baden
Tel.: 07223 967-0

Issue Date: December 2014

Copyright: © 2014, Schöck Bauteile GmbH
All rights reserved. No part of this document may be reproduced or copied in any form or by any means – graphic, electronic, or mechanical, including photocopying, taping, or information storage and retrieval systems - unless permission in writing is obtained from Schöck Bauteile GmbH.



Subject to technical alterations
Issued: December 2014

Schöck Bauteile GmbH
Vimbucherstrasse 2
76534 Baden-Baden
Germany
Tel. +49 7223 967-449
Fax +49 7223 967-490
combar@schoeck.com
www.schoeck-combar.com

